

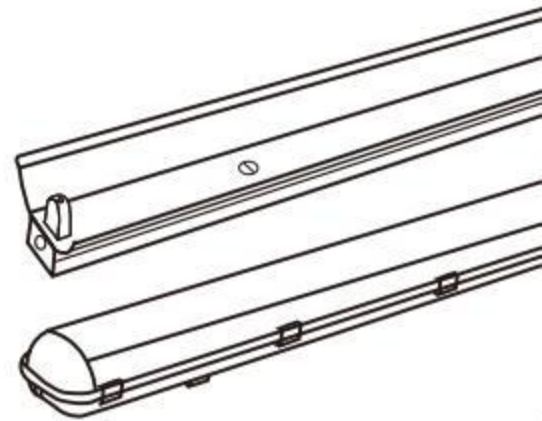

CATALOG

10. Batten & IP65

EASTLIKE LED Co., Ltd



LED Lighting Series

Green

Low Carbon

Energy Saving





公司簡介 Company Profile



製造和營銷綠色低碳節能照明產品
Manufacturing And Marketing Green Low Carbon
And Energy Saving Lighting Products

LED Lighting



EASTLIKE LED COMPANY 東 欖 照 明 公 司

EASTLIKE LED Co., Ltd • emerges as a lighting designer manufacturer and supplier established in Hong Kong and Mainland China .

The company devotes herself in the development, manufacturing and marketing of green, low-carbon and energy-saving lighting products. we are proud to provide a wide range of LED products

東欖LED照明公司•您的照明設計師。

我們作為製造商和供應服務於香港和中國大陸。公司致力於開發，製造和行銷綠色，低碳和節能照明產品。

我們竭誠為您服務，為您提供種類繁多的LED產品。

目录

Content



P.01
T8 英式單支架



P.02
T5 英式單支架



P.03
T8 普通單支架



P.04
T5 普通單支架



P.05
T8 英式雙支架



P.06
T5 英式雙支架



P.07
T8 防水單支架



P.08
T8 防水雙支架



P.09
T8 單支乳白防水支架



P.10
T8 雙支乳白防水支架



P.11
T8 單支條紋PC防水支架



P.12
T8 雙支條紋PC防水支架

T8 British Single Battens

Series Type: EDBE8

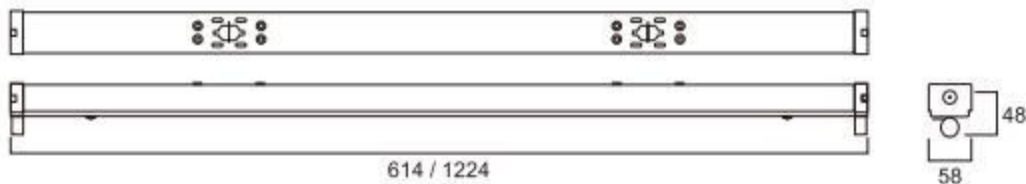

614 / 1224

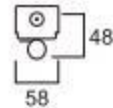

(Unit : mm)

Features 產品特點

- ★ The shell adopts arc streamline design, novel and unique
- ★ Electrostatic spraying treatment, which is durable
- ★ The lamp holder adopts cut in rotary design, safe and reliable
- ★ Applicable places: family, school, office, factory, etc

- ★ 外殼採用弧面流線設計, 新穎獨特
- ★ 靜電噴塗處理, 經久耐用
- ★ 燈座採用切入旋轉式設計, 安全可靠
- ★ 適用場所: 家庭、學校、辦公室、工廠等

Specification 產品規格

Model 型號	Size 尺寸 (mm)	Number Of Tube 燈管數量 (pcs)	Material 材料	IP Grade IP等級	Weight 重量 (kg)	Carton Size 外箱尺寸 (mm)	PCS / CTN 每箱數量 (pcs)
EDBA-S06-EN	614*58*48	1pcs*0.6m(2ft)	Cold-rolled steel	IP 20	0.65	620*20*20	8
EDBA-S12-EN	1224*58*48	1pcs*1.2m(4ft)	Cold-rolled steel	IP 20	1.29	1230*20*20	8

Light efficiency (lm/W), Power (W), Color Rendering Index (CRI), Can be customized according to customer needs.

Our Standard Power factor (PF) > 0.9 and Total harmonic index THD < 15%, According to customer requirements can produce a lower THD < 10%.

This type of certification is issued by a government-approved laboratory for Safety certification, Fire testing, Restriction of Hazardous Substances (RoHS), Photobiological safety of lamps and lamp systems. (an Exemption Group) and other test certifications to ensure product quality

光效 (lm/W)、功率 (W)、顯色指數 (CRI), 可根據客戶需求定制。

此型號標準之功率因素 (PF) > 0.9, 總諧波指數 THD < 15%, 可按客戶需要生產低總諧波指數 < 10%。

此型號認證由可實驗室發出之安全認證消防測試, 環保物料 (RoHS), 光生物安全為 Exemption Group 及其它測試, 保證客戶使用更安心滿意。

T5 British Single Battens

Series Type: EDBE5

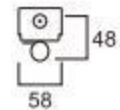
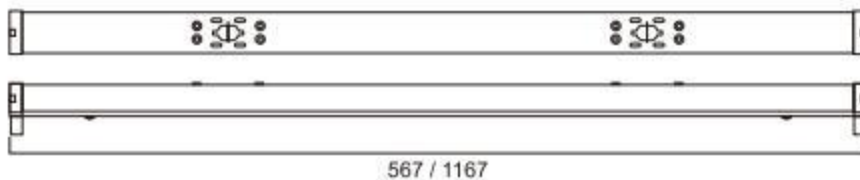

567 / 1167

(Unit : mm)

Features 產品特點

- ★ The shell adopts arc streamline design, novel and unique
- ★ Electrostatic spraying treatment, which is durable
- ★ The lamp holder adopts cut in rotary design, safe and reliable
- ★ Applicable places: family, school, office, factory, etc

- ★ 外殼採用弧面流線設計，新穎獨特
- ★ 靜電噴塗處理，經久耐用
- ★ 燈座採用切入旋轉式設計，安全可靠
- ★ 適用場所：家庭、學校、辦公室、工廠等

Specification 產品規格

Model 型號	Size 尺寸 (mm)	Number Of Tube 燈管數量 (pcs)	Material 材料	IP Grade IP等級	Weight 重量 (kg)	Carton Size 外箱尺寸 (mm)	PCS / CTN 每箱數量 (pcs)
EDBA-S06-EN-T5	567*58*48	1pcs*0.6m(2ft)	Cold-rolled steel	IP 20	0.62	620*60*60	8
EDBA-S12-EN-T5	1167*58*48	1pcs*1.2m(4ft)	Cold-rolled steel	IP 20	1.26	1230*80*60	8

Light efficiency (lm/W), Power (W), Color Rendering Index (CRI), Can be customized according to customer needs.

Our Standard Power factor (PF) > 0.9 and Total harmonic index THD < 15%, According to customer requirements can produce a lower THD < 10%.

This type of certification is issued by a government-approved laboratory for Safety certification, Fire testing, Restriction of Hazardous Substances (RoHS), Photobiological safety of lamps and lamp systems, (an Exemption Group) and other test certifications to ensure product quality

光效 (lm/W)、功率 (W)、顯色指數 (CRI)，可根據客戶需求定制。

此型號標準之功率因素 (PF) > 0.9，總諧波指數 THD < 15%，可按客戶需要生產低總諧波指數 < 10%。

此型號認證由可實驗室發出之安全認證消防測試，環保物料 (RoHS)，光生物安全為 Exemption Group 及其它測試，保證客戶使用更安心滿意。

T8 Ordinary Single Support

Series Type: EDBC8

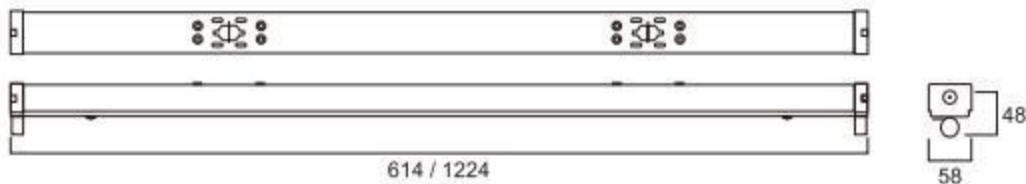

(Unit : mm)

Features 產品特點

- ★ The shell adopts arc streamline design, novel and unique
- ★ Electrostatic spraying treatment, which is durable
- ★ The lamp holder adopts cut in rotary design, safe and reliable
- ★ Applicable places: family, school, office, factory, etc

- ★ 外殼採用弧面流線設計, 新穎獨特
- ★ 靜電噴塗處理, 經久耐用
- ★ 燈座採用切入旋轉式設計, 安全可靠
- ★ 適用場所: 家庭、學校、辦公室、工廠等

Specification 產品規格

Model 型號	Size 尺寸 (mm)	Number Of Tube 燈管數量 (pcs)	Material 材料	IP Grade IP等級	Weight 重量 (kg)	Carton Size 外箱尺寸 (mm)	PCS / CTN 每箱數量 (pcs)
EDBA-S0609-Y	614*58*48	1pcs*0.6m(2ft)	Iron	IP 20	0.55	640*80*60	8
EDBA-S1218-Y	1224*58*48	1pcs*1.2m(4ft)	Iron	IP 20	1.15	1240*80*60	8

Light efficiency (lm/W), Power (W), Color Rendering Index (CRI), Can be customized according to customer needs.

Our Standard Power factor (PF) > 0.9 and Total harmonic index THD < 15%, According to customer requirements can produce a lower THD < 10%.

This type of certification is issued by a government-approved laboratory for Safety certification, Fire testing, Restriction of Hazardous Substances (RoHS), Photobiological safety of lamps and lamp systems. (an Exemption Group) and other test certifications to ensure product quality

光效 (lm/W)、功率 (W)、顯色指數 (CRI), 可根據客戶需求定制。

此型號標準之功率因素 (PF) > 0.9, 總諧波指數 THD < 15%, 可按客戶需要生產低總諧波指數 < 10%。

此型號認證由可實驗室發出之安全認證消防測試, 環保物料 (RoHS), 光生物安全為 Exemption Group 及其它測試, 保證客戶使用更安心滿意。

T5 Ordinary Single Support

Series Type: EDBC5

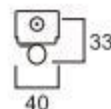
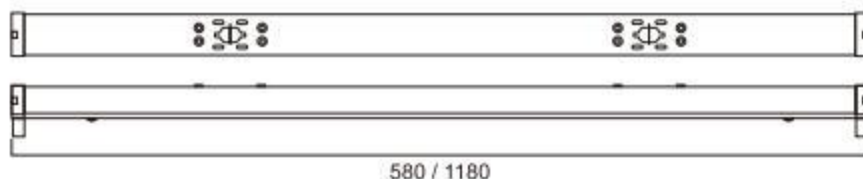

(Unit : mm)

Features 產品特點

- ★ The shell adopts arc streamline design, novel and unique
- ★ Electrostatic spraying treatment, which is durable
- ★ The lamp holder adopts cut in rotary design, safe and reliable
- ★ Applicable places: family, school, office, factory, etc

- ★ 外殼採用弧面流線設計，新穎獨特
- ★ 靜電噴塗處理，經久耐用
- ★ 燈座採用切入旋轉式設計，安全可靠
- ★ 適用場所：家庭、學校、辦公室、工廠等

Specification 產品規格

Model 型號	Size 尺寸 (mm)	Number Of Tube 燈管數量 (pcs)	Material 材料	IP Grade IP等級	Weight 重量 (kg)	Carton Size 外箱尺寸 (mm)	PCS / CTN 每箱數量 (pcs)
EDBA-S50609-Y	580*40*30	1pcs*0.6m(2ft)	Iron	IP 20	0.5	640*80*60	8
EDBA-S51218-Y	1180*40*33	1pcs*1.2m(4ft)	Iron	IP 20	1	1240*80*60	8

Light efficiency (lm/W), Power (W), Color Rendering Index (CRI), Can be customized according to customer needs.

Our Standard Power factor (PF) > 0.9 and Total harmonic index THD < 15%, According to customer requirements can produce a lower THD < 10%.

This type of certification is issued by a government-approved laboratory for Safety certification, Fire testing, Restriction of Hazardous Substances (RoHS), Photobiological safety of lamps and lamp systems, (an Exemption Group) and other test certifications to ensure product quality

光效 (lm/W)、功率 (W)、顯色指數 (CRI)，可根據客戶需求定制。

此型號標準之功率因素 (PF) > 0.9，總諧波指數 THD < 15%，可按客戶需要生產低總諧波指數 < 10%。

此型號認證由可實驗室發出之安全認證消防測試，環保物料 (RoHS)，光生物安全為 Exemption Group 及其它測試，保證客戶使用更安心滿意。

T8 British Double Bracke

Series Type: EDDE8

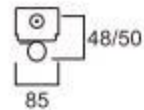
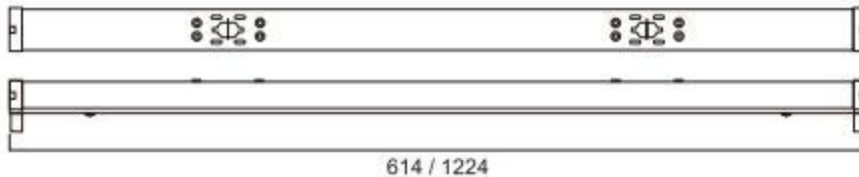

614 / 1224

(Unit : mm)

Features 產品特點

- ★ The shell adopts arc streamline design, novel and unique
- ★ Electrostatic spraying treatment, which is durable
- ★ The lamp holder adopts cut in rotary design, safe and reliable
- ★ Applicable places: family, school, office, factory, etc

- ★ 外殼採用弧面流線設計, 新穎獨特
- ★ 靜電噴塗處理, 經久耐用
- ★ 燈座採用切入旋轉式設計, 安全可靠
- ★ 適用場所: 家庭、學校、辦公室、工廠等

Specification 產品規格

Model 型號	Size 尺寸 (mm)	Number Of Tube 燈管數量 (pcs)	Material 材料	IP Grade IP等級	Weight 重量 (kg)	Carton Size 外箱尺寸 (mm)	PCS / CTN 每箱數量 (pcs)
EDBA-D06-EN	614*85*48	2pcs*0.6m(2ft)	Cold-rolled steel	IP 20	0.66	640*100*75	8
EDBA-D12-EN	1224*85*50	2pcs*1.2m(4ft)	Cold-rolled steel	IP 20	1.3	1240*100*75	8

Light efficiency (lm/W), Power (W), Color Rendering Index (CRI), Can be customized according to customer needs.

Our Standard Power factor (PF) > 0.9 and Total harmonic index THD < 15%, According to customer requirements can produce a lower THD < 10%.

This type of certification is issued by a government-approved laboratory for Safety certification, Fire testing, Restriction of Hazardous Substances (RoHS), Photobiological safety of lamps and lamp systems. (an Exemption Group) and other test certifications to ensure product quality

光效 (lm/W)、功率 (W)、顯色指數 (CRI), 可根據客戶需求定制。

此型號標準之功率因素 (PF) > 0.9, 總諧波指數 THD < 15%, 可按客戶需要生產低總諧波指數 < 10%。

此型號認證由可實驗室發出之安全認證消防測試, 環保物料 (RoHS), 光生物安全為 Exemption Group 及其它測試, 保證客戶使用更安心滿意。

T5 British Double Bracke

Series Type: EDDE5

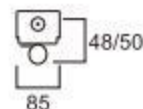
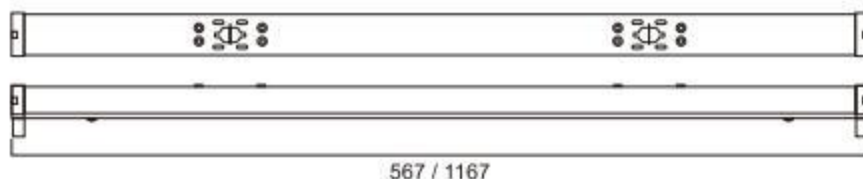

(Unit : mm)

Features 產品特點

- ★ The shell adopts arc streamline design, novel and unique
- ★ Electrostatic spraying treatment, which is durable
- ★ The lamp holder adopts cut in rotary design, safe and reliable
- ★ Applicable places: family, school, office, factory, etc

- ★ 外殼採用弧面流線設計，新穎獨特
- ★ 靜電噴塗處理，經久耐用
- ★ 燈座採用切入旋轉式設計，安全可靠
- ★ 適用場所：家庭、學校、辦公室、工廠等

Specification 產品規格

Model 型號	Size 尺寸 (mm)	Number Of Tube 燈管數量 (pcs)	Material 材料	IP Grade IP等級	Weight 重量 (kg)	Carton Size 外箱尺寸 (mm)	PCS / CTN 每箱數量 (pcs)
EDBA-D06-EN-T5	567*85*48	2pcs*0.6m(2ft)	Cold-rolled steel	IP 20	0.63	620*100*75	8
EDBA-D12-EN-T5	1167*85*50	2pcs*1.2m(4ft)	Cold-rolled steel	IP 20	1.27	1180*100*75	8

Light efficiency (lm/W), Power (W), Color Rendering Index (CRI), Can be customized according to customer needs.

Our Standard Power factor (PF) > 0.9 and Total harmonic index THD < 15%, According to customer requirements can produce a lower THD < 10%.

This type of certification is issued by a government-approved laboratory for Safety certification, Fire testing, Restriction of Hazardous Substances (RoHS), Photobiological safety of lamps and lamp systems, (an Exemption Group) and other test certifications to ensure product quality

光效 (lm/W)、功率 (W)、顯色指數 (CRI)，可根據客戶需求定制。

此型號標準之功率因素 (PF) > 0.9，總諧波指數 THD < 15%，可按客戶需要生產低總諧波指數 < 10%。

此型號認證由可實驗室發出之安全認證消防測試，環保物料 (RoHS)，光生物安全為 Exemption Group 及其它測試，保證客戶使用更安心滿意。

T8 Waterproof Single Support

Series Type: EIPP8

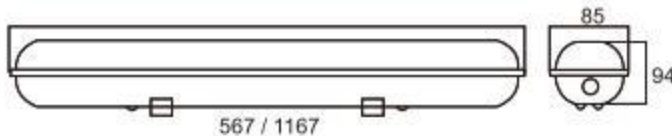

(Unit : mm)

Features 產品特點

- ★ Waterproof grade: IP65; Certification standard: CE RoHS
- ★ It has waterproof, dustproof, insect proof
- ★ Suitable for T8 and T5 fluorescent tubes, LED tubes
- ★ Made of high-quality PC material, it is not easy to crack
- ★ Various materials: PC, PS, ABS optional

- ★ 防水等級:IP65,認證標準:CE ROHS
- ★ 具有防水、防塵、防蟲
- ★ 適合T8和T5螢光燈管,LED燈管
- ★ 採用優質PC材料製作,不易破裂
- ★ 多種材料:PC、PS、ABS可選

Specification 產品規格

Model 型號	Size 尺寸 (mm)	Number Of Tube 燈管數量 (pcs)	Material 材料	IP Grade IP等級	Weight 重量 (kg)	Carton Size 外箱尺寸 (mm)	PCS / CTN 每箱數量 (pcs)
EIP8-P0609-N65-S	660*85*94	1pcs*0.6m(2ft)	ABS+PC	IP 65	0.9	685*100*110	8
EIP8-P1218-N65-S	1270*85*94	1pcs*1.2m(4ft)	ABS+PC	IP 65	1.7	1295*100*110	8

Light efficiency (lm/W), Power (W), Color Rendering Index (CRI), Can be customized according to customer needs.

Our Standard Power factor (PF) > 0.9 and Total harmonic index THD < 15%, According to customer requirements can produce a lower THD < 10%.

This type of certification is issued by a government-approved laboratory for Safety certification, Fire testing, Restriction of Hazardous Substances (RoHS), Photobiological safety of lamps and lamp systems. (an Exemption Group) and other test certifications to ensure product quality

光效 (lm/W)、功率 (W)、顯色指數 (CRI), 可根據客戶需求定制。

此型號標準之功率因素 (PF) > 0.9, 總諧波指數 THD < 15%, 可按客戶需要生產低總諧波指數 < 10%。

此型號認證由可實驗室發出之安全認證消防測試, 環保物料 (RoHS), 光生物安全為 Exemption Group 及其它測試, 保證客戶使用更安心滿意。

T8 Waterproof Double Support

Series Type: EIDP8

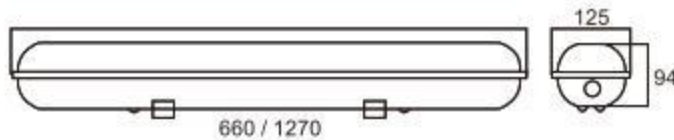

(Unit : mm)

Features 產品特點

- ★ Waterproof grade: IP65; Certification standard: CE RoHS
- ★ It has waterproof, dustproof, insect proof
- ★ Suitable for T8 and T5 fluorescent tubes, LED tubes
- ★ Made of high-quality PC material, it is not easy to crack
- ★ Various materials: PC, PS, ABS optional

- ★ 防水等級: IP65; 認證標準: CE ROHS
- ★ 具有防水、防塵、防蟲
- ★ 適合T8和T5螢光燈管, LED燈管
- ★ 採用優質PC材料製作, 不易破裂
- ★ 多種材料: PC、PS、ABS可選

Specification 產品規格

Model 型號	Size 尺寸 (mm)	Number Of Tube 燈管數量 (pcs)	Material 材料	IP Grade IP等級	Weight 重量 (kg)	Carton Size 外箱尺寸 (mm)	PCS / CTN 每箱數量 (pcs)
EIPB-P0609-N65-D	660*125*94	2pcs*0.6m(2ft)	ABS+PC	IP 65	1.2	685*150*110	8
EIPB-P1218-N65-D	1270*125*94	2pcs*1.2m(4ft)	ABS+PC	IP 65	2.3	1295*150*110	8

Light efficiency (lm/W), Power (W), Color Rendering Index (CRI), Can be customized according to customer needs.

Our Standard Power factor (PF) > 0.9 and Total harmonic index THD < 15%, According to customer requirements can produce a lower THD < 10%.

This type of certification is issued by a government-approved laboratory for Safety certification, Fire testing, Restriction of Hazardous Substances (RoHS), Photobiological safety of lamps and lamp systems, (an Exemption Group) and other test certifications to ensure product quality

光效 (lm/W)、功率 (W)、顯色指數 (CRI), 可根據客戶需求定制。

此型號標準之功率因素 (PF) > 0.9, 總諧波指數 THD < 15%, 可按客戶需要生產低總諧波指數 < 10%。

此型號認證由可實驗室發出之安全認證消防測試, 環保物料 (RoHS), 光生物安全為 Exemption Group 及其它測試, 保證客戶使用更安心滿意。

T8 Single Milky White Waterproof Support

Series Type: EIPW8

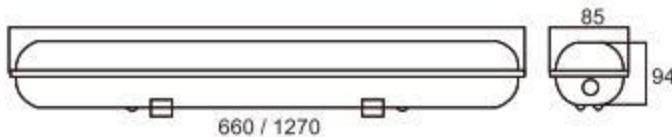

(Unit : mm)

Features 產品特點

- ★ The lamp body is designed with dust-proof, waterproof functions
- ★ Good toughness and strong impact resistance
- ★ High light transmittance and uniform brightness
- ★ High thermal conductivity and good heat dissipation
- ★ The lamp body and mask are sealed with high elastic rubber ring and stainless steel buckle
- ★ 燈體設計具有防塵, 防水功能
- ★ 韌性好, 抗衝擊性強
- ★ 透光率高, 亮度均勻
- ★ 導熱係數高, 散熱好
- ★ 燈體與面罩之間採用高彈性橡膠膠圈密封, 不銹鋼鉗扣

Specification 產品規格

Model 型號	Size 尺寸 (mm)	Number Of Tube 燈管數量 (pcs)	Material 材料	IP Grade IP等級	Weight 重量 (kg)	Carton Size 外箱尺寸 (mm)	PCS / CTN 每箱數量 (pcs)
EIP8-P0609-N65-S-M	660*85*94	1pcs*0.6m(2ft)	ABS+PC	IP 65	0.9	685*100*110	8
EIP8-P1218-N65-S-M	1270*85*94	1pcs*1.2m(4ft)	ABS+PC	IP 65	1.7	1295*100*110	8

Light efficiency (lm/W), Power (W), Color Rendering Index (CRI), Can be customized according to customer needs.

Our Standard Power factor (PF) > 0.9 and Total harmonic index THD < 15%, According to customer requirements can produce a lower THD < 10%.

This type of certification is issued by a government-approved laboratory for Safety certification, Fire testing, Restriction of Hazardous Substances (RoHS), Photobiological safety of lamps and lamp systems. (an Exemption Group) and other test certifications to ensure product quality

光效 (lm/W)、功率 (W)、顯色指數 (CRI), 可根據客戶需求定制。

此型號標準之功率因素 (PF) > 0.9, 總諧波指數 THD < 15%, 可按客戶需要生產低總諧波指數 < 10%。

此型號認證由可實驗室發出之安全認證消防測試, 環保物料 (RoHS), 光生物安全為 Exemption Group 及其它測試, 保證客戶使用更安心滿意。

T8 Double Milky White Waterproof Support

Series Type: EIDW8

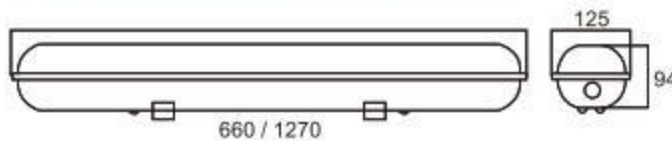

(Unit: mm)

Features 產品特點

- ★ The lamp body is designed with dust-proof, waterproof functions
- ★ Good toughness and strong impact resistance
- ★ High light transmittance and uniform brightness
- ★ High thermal conductivity and good heat dissipation
- ★ The lamp body and mask are sealed with high elastic rubber ring and stainless steel buckle
- ★ 燈體設計具有防塵, 防水功能
- ★ 韌性好, 抗衝擊性強
- ★ 透光率高, 亮度均勻
- ★ 導熱係數高, 散熱好
- ★ 燈體與面罩之間採用高彈性橡膠膠圈密封, 不銹鋼鉗扣

Specification 產品規格

Model 型號	Size 尺寸 (mm)	Number Of Tube 燈管數量 (pcs)	Material 材料	IP Grade IP等級	Weight 重量 (kg)	Carton Size 外箱尺寸 (mm)	PCS / CTN 每箱數量 (pcs)
EIPB-P0609-N65-D-M	660*125*94	2pcs*0.6m(2ft)	ABS+PC	IP 65	1.2	685*150*110	8
EIPB-P1218-N65-D-M	1270*125*94	2pcs*1.2m(4ft)	ABS+PC	IP 65	2.3	1295*150*110	8

Light efficiency (lm/W), Power (W), Color Rendering Index (CRI), Can be customized according to customer needs.

Our Standard Power factor (PF) > 0.9 and Total harmonic index THD < 15%, According to customer requirements can produce a lower THD < 10%.

This type of certification is issued by a government-approved laboratory for Safety certification, Fire testing, Restriction of Hazardous Substances (RoHS), Photobiological safety of lamps and lamp systems, (an Exemption Group) and other test certifications to ensure product quality

光效 (lm/W)、功率 (W)、顯色指數 (CRI), 可根據客戶需求定制。

此型號標準之功率因素 (PF) > 0.9, 總諧波指數 THD < 15%, 可按客戶需要生產低總諧波指數 < 10%。

此型號認證由可實驗室發出之安全認證消防測試, 環保物料 (RoHS), 光生物安全為 Exemption Group 及其它測試, 保證客戶使用更安心滿意。

T8 Single Stripe PC Waterproof Support

Series Type: EIPC8

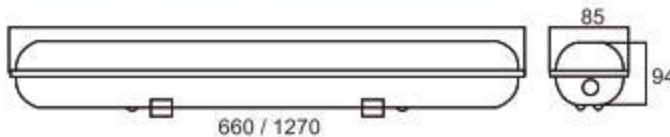

(Unit : mm)

Features 產品特點

- ★ The lamp body is designed with dust-proof, waterproof functions
- ★ Good toughness and strong impact resistance
- ★ High light transmittance and uniform brightness
- ★ High thermal conductivity and good heat dissipation
- ★ The lamp body and mask are sealed with high elastic rubber ring and stainless steel buckle
- ★ 燈體設計具有防塵, 防水功能
- ★ 韌性好, 抗衝擊性強
- ★ 透光率高, 亮度均勻
- ★ 導熱係數高, 散熱好
- ★ 燈體與面罩之間採用高彈性橡膠膠圈密封, 不銹鋼鉗扣

Specification 產品規格

Model 型號	Size 尺寸 (mm)	Number Of Tube 燈管數量 (pcs)	Material 材料	IP Grade IP等級	Weight 重量 (kg)	Carton Size 外箱尺寸 (mm)	PCS / CTN 每箱數量 (pcs)
EIP8-P0609-N65-S-S	660*85*94	1pcs*0.6m(2ft)	ABS+PC	IP 65	0.9	685*100*110	8
EIP8-P1218-N65-S-S	1270*85*94	1pcs*1.2m(4ft)	ABS+PC	IP 65	1.7	1295*100*110	8

Light efficiency (lm/W), Power (W), Color Rendering Index (CRI), Can be customized according to customer needs.

Our Standard Power factor (PF) > 0.9 and Total harmonic index THD < 15%, According to customer requirements can produce a lower THD < 10%.

This type of certification is issued by a government-approved laboratory for Safety certification, Fire testing, Restriction of Hazardous Substances (RoHS), Photobiological safety of lamps and lamp systems. (an Exemption Group) and other test certifications to ensure product quality

光效 (lm/W)、功率 (W)、顯色指數 (CRI), 可根據客戶需求定制。

此型號標準之功率因素 (PF) > 0.9, 總諧波指數 THD < 15%, 可按客戶需要生產低總諧波指數 < 10%。

此型號認證由可實驗室發出之安全認證消防測試, 環保物料 (RoHS), 光生物安全為 Exemption Group 及其它測試, 保證客戶使用更安心滿意。

T8 Double Striped PC Waterproof Support

Series Type: EIDC8

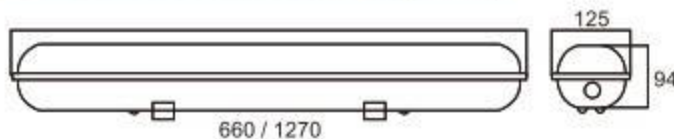

(Unit: mm)

Features 產品特點

- ★ The lamp body is designed with dust-proof, waterproof functions
- ★ Good toughness and strong impact resistance
- ★ High light transmittance and uniform brightness
- ★ High thermal conductivity and good heat dissipation
- ★ The lamp body and mask are sealed with high elastic rubber ring and stainless steel buckle

- ★ 燈體設計具有防塵, 防水功能
- ★ 韌性好, 抗衝擊性強
- ★ 透光率高, 亮度均勻
- ★ 導熱係數高, 散熱好
- ★ 燈體與面罩之間採用高彈性橡膠膠圈密封, 不銹鋼鉗扣

Specification 產品規格

Model 型號	Size 尺寸 (mm)	Number Of Tube 燈管數量 (pcs)	Material 材料	IP Grade IP等級	Weight 重量 (kg)	Carton Size 外箱尺寸 (mm)	PCS / CTN 每箱數量 (pcs)
EIPB-P0609-N65-D-S	660*125*94	2pcs*0.6m(2ft)	ABS+PC	IP 65	1.2	685*150*110	8
EIPB-P1218-N65-D-S	1270*125*94	2pcs*1.2m(4ft)	ABS+PC	IP 65	2.3	1295*150*110	8

Light efficiency (lm/W), Power (W), Color Rendering Index (CRI), Can be customized according to customer needs.

Our Standard Power factor (PF) > 0.9 and Total harmonic index THD < 15%, According to customer requirements can produce a lower THD < 10%.

This type of certification is issued by a government-approved laboratory for Safety certification, Fire testing, Restriction of Hazardous Substances (RoHS), Photobiological safety of lamps and lamp systems, (an Exemption Group) and other test certifications to ensure product quality

光效 (lm/W)、功率 (W)、顯色指數 (CRI), 可根據客戶需求定制。

此型號標準之功率因素 (PF) > 0.9, 總諧波指數 THD < 15%, 可按客戶需要生產低總諧波指數 < 10%。

此型號認證由可實驗室發出之安全認證消防測試, 環保物料 (RoHS), 光生物安全為 Exemption Group 及其它測試, 保證客戶使用更安心滿意。

東 權 LED 照 明 公 司
EASTLIKE LED Co., Ltd

Office Address: Room B3, 18/F Bonsun Industrial Building,
364-366 Sha Tsui Road, Tsuen Wan, HongKong

Phone: 852-3107 7500

Fax: 852-3544 0462

Whatsapp: 852-5977 2627

Email: info@eastlike.com