

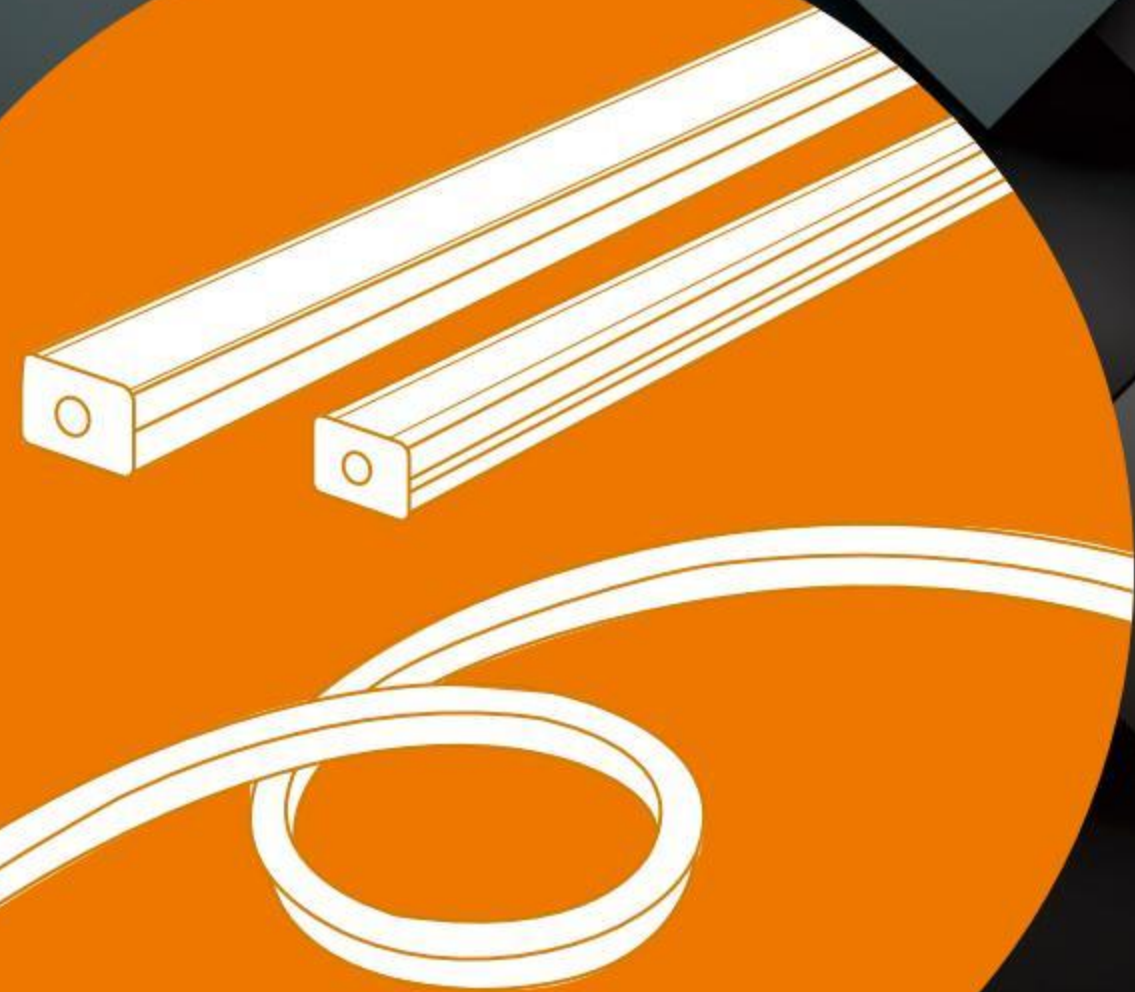

LED LIGHTING SERIES CATALOG

Kitchen and Cabinet Lights



iLighting Global Enterprise Co., Ltd.

Office Address: Room B3, 18/F Bonsun Industrial Building,
364-366 Sha Tsui Road, Tsuen Wan, HongKong

Phone: 852-3107 7500

Fax: 852-3544 0462

Email: info@ilighting.com.hk

Website: www.ilighting.com.hk



iLighting Global Enterprise Co., Ltd.

www.ilighting.com.hk



Catalog Series: 2B

KITCHEN AND CABINET LIGHT

LED Lighting Series



*i*LIGHTING®
Green • Professional

LED
Lighting
Series

CONTENTS

CONTENTS

Company Profile 公司簡介	1-2
Lighting Basic Concept 照明基本概念	3-8
Thermal Conductive LED Strip 導熱燈條	9-13
Aluminum LED Strip LED鋁燈條	14-29
Soft Light Strip Series 軟光條系列	30-35
Transparent waterproof series 透明防水系列	36-39
Neon Light Series 霓虹燈系列	40-56
Cabinet Light Series 櫃燈系列	57-64

A

thermal conductive
LED strip
導熱燈條



B

aluminum LED strip
LED鋁燈條



C

soft light strip series
軟光條系列

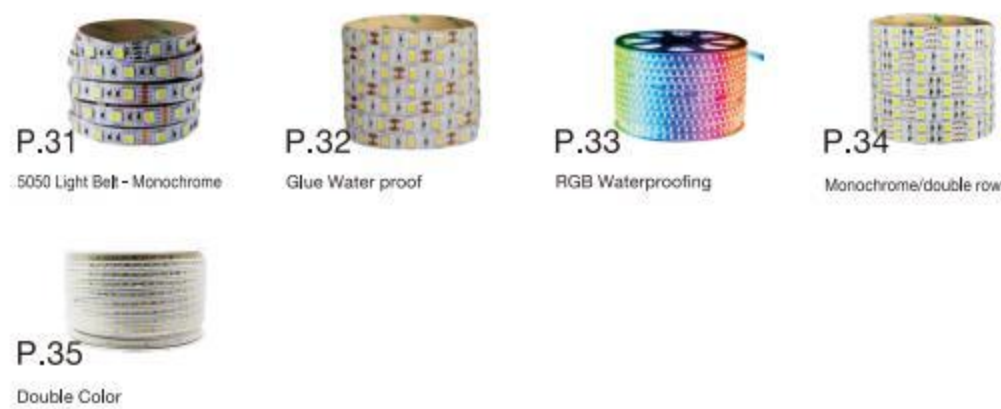

D

transparent
waterproof series
透明防水系列



E

neon light series
霓虹燈系列



F

cabinet light series
櫃燈系列



Company Profile

公司簡介

ABOUT US 關於我們

iLIGHTING Global Enterprise Co. Ltd. emerges as a professional and high-end lighting designer, manufacturer and supplier established in Hong Kong and Mainland China under the Brand name 'iLighting' since 2007. The company is also a strategic OEM/ODM partner of many organization-wide lighting brands. The company devotes herself in the development, manufacturing and marketing of green, low-carbon and energy-saving lighting products. With continuous investment on R&D, we are proud to provide a wide range of LED products and work with worldwide partners in developing and managing Energy Management System (EMS) through the application of 5G and WiFi technology.

iLIGHTING智能環球企業有限公司成立於2007年是一家集高端照明設計、製造和供應為一體的專業照明公司，自2007年起在香港和中國大陸以“iLighting”的名字成立。公司也是許多照明品牌的戰略性OEM/ODM合作夥伴。公司致力於綠色、低碳、節能照明產品的開發、製造和銷售。憑藉對研發的持續投資，我們自豪地提供範圍廣泛的LED產品，並通過應用5G和WiFi科技與全球合作夥伴合作開發和管理能源管理系統(EMS)。

Product Capacity 生產能力

- LED lighting with integrated design and built-in advanced electronic driver for building lighting retrofit.
- LED indoor and outdoor lighting with internal and external drivers.
- LED lighting emergency fitting and charging packs.
- Extra long life LED lamps for high power high bay and flood lights.
- Total system solution for dimming lighting control deploying WiFi, DALI, Lonwork, Bluetooth 4.0, Zigbee technologies.
- OEM / ODM energy saving lighting as required by clients for new and retrofit installation.
- Total Energy Management Solution for Intelligent Building Management.
- LED照明與集成設計和內置先進的電子驅動器，用於建築照明改造。
- 室內和室外LED照明，有內部和外部驅動器。
- LED照明應急配件和充電器。
- 超長壽命LED燈，適用於大功率高位燈和泛光燈。
- 全系統調光照明控制解決方案，採用WiFi、DALI、Lonwork、Bluetooth 4.0、Zigbee 通訊技術。
- OEM/ODM節能照明，可根據客戶的要求進行更新改造。
- 智能建築管理總能源管理解決方案。

Our Mission 我們的使命

We look to serve our client with the best quality of products and viable solutions of energy management system through intelligent system integration. Product adaptability is our strength ; continuous improvement is our norm of work and meeting customer satisfaction is our goal.

我們希望通過智能系統集成，為客戶提供最優質的產品和可行的能源管理系統解決方案。產品適應性是我們的優勢，持續改進是我們的工作準則，讓客戶滿意是我們的目標。

Our Advantages 我們的優勢

- Excellent after-sale services.
- OEM and ODM for global lighting companies.
- Flexible design and tailor-made products to suit retrofit projects.
- 優良的售後服務。
- 為全球照明公司提供OEM和ODM。
- 靈活的設計和訂制的產品，以適應更新改造項目。



Office Address:

Room B3, 18/F Bonsun Industrial Building, 364-366 Sha Tsui Road, Tsuen Wan, HongKong

Phone: 852-3107 7500

Fax 852-3544 0462

E-mail info@ilighting.com.hk

Website: www.ilighting.com.hk

Lighting Basic Concept

照明基本概念

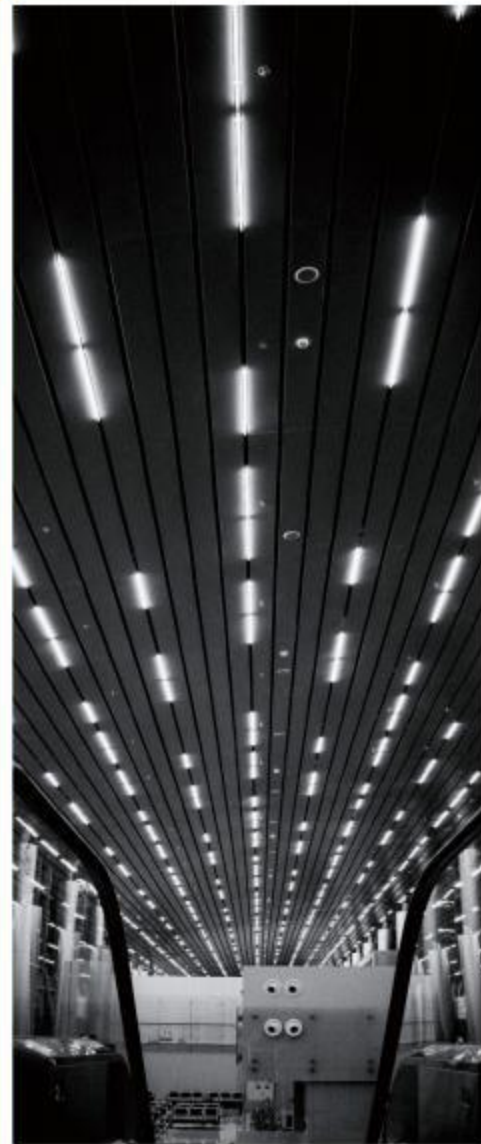

Lumen 流明

Lumen 實際上是代表著光的強度，也就是光通量 (Luminous flux) 即指光源在某單位時間內所發出之光線總數量。一般稱作光束)的單位，簡而言之，流明就是光束照在物體表面的量。

Lumen actually represents the intensity of lights, that is, the luminous flux(Luminous Flux) refers to the unit of the total amount of light emitted by a light source in a unit time, generally referred to as the light beam. In short, lumens is the light beam Amount on the surface of the object.

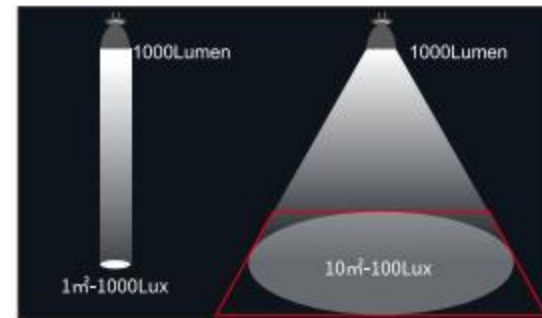

Color Rendering Index 顯色性指數

顯色度以Ra來表示，天然光的顯色度為100Ra，顯色度越接近100Ra，我們看到的顏色就越接近物體的自然原色。也就是顏色逼真的程度，顯色度高 我們所看到的顏色也就是較接近自然原色，顯色度低對於顏色的表現較差，所看到的顏色偏差也延遲。

Color rendering is represented by Ra, the color rendering of natural light is 100 Ra, the closer the color rendering is to 100 Ra, the color we see is closer to the natural primary color of the object. Color is realistic. The degree of color rendering is high. The color we see is close to natural primary color, low color rendering, poor performance for color, The color deviation seen is also delayed.

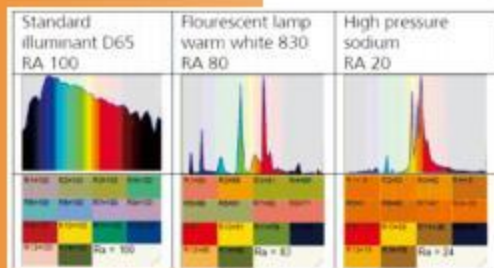

Color Temperature 色溫

色溫及不同色溫應用什麼環境——以絕對溫度 K (kelvin) 來表示，色溫度 3000k 以下時，光色有偏紅的現象 (黃光)，給予一種溫暖、親切、舒適的感覺；色溫度超過 5000k 時，顏色則偏向藍光 (白光)，給人一種清冷的感覺，令環境變得清冷和寧靜。

通常亞熱帶人較喜歡清冷 4000k 以上，而寒帶的人較喜歡 4000k 以下的色溫度。

Color temperature and what environment is used for different color temperatures-expressed in absolute temperature K (kelvin), when the color temperature is below 3000k, the light color has a reddish phenomenon (yellow light), giving a warm, friendly, comfortable feeling; color temperature exceeds 5000k at this time, the color is biased towards blue light (white light), giving a cool feeling. Make the environment clear and peaceful.

Generally, people in the subtropics prefer cold temperatures above 4000k, while those in the cold regions prefer colors below 4000k.

WB SETTINGS	COLOR TEMPERATURE	LIGHT SOURCES
	10000-15000K	Clear Blue Sky
	6500-8000K	Cloudy Sky / Shade
	6000-7000K	Noon Sunlight
	5500-6500K	Average Daylight
	5000-5500K	Electronic Flash
	4000-5000K	Fluorescent Light
	3000-4000K	Early AM/ Late PM
	2500-3000K	Domestic Lightning
	1000-2000K	Candle Flame



Life 壽命

分為平均壽命和經濟壽命兩種，以小時為單位。

平均壽命 (rate average life)

例如，每個100個燈泡同時亮著，若6000小時後，第50個燈泡壞掉熄滅，此燈泡的平均壽命則為6000小時。

經濟壽命 (economic life)

指流明輸出的總時數

以上，燈的光通維持率達到標準規定的要求並能繼續燃點至50%的燈 (即50%的燈失效時的壽命)，同時考慮損壞以及光束輸出衰減的狀況下能維持光源為70%以上。

Divided into two types of average life and economic life, in hours.

Life expectancy (rate average life)

For example, each of the 100 light bulbs is on at the same time. If after 60,000 hours, The 50th lamp is broken and extinguished, and the average life of the lamp is 60000 hours.

Economic life

Economic life refers to lumen output.

The above, The lumen maintenance rate of the indicator lamp meets the requirements of the standard that can continue burning point to 50% of lamps (ie, that point at 50% of lamp fails). Taking into account for the damage, lumen output decay, it can maintain light source at 70% healthy condition.

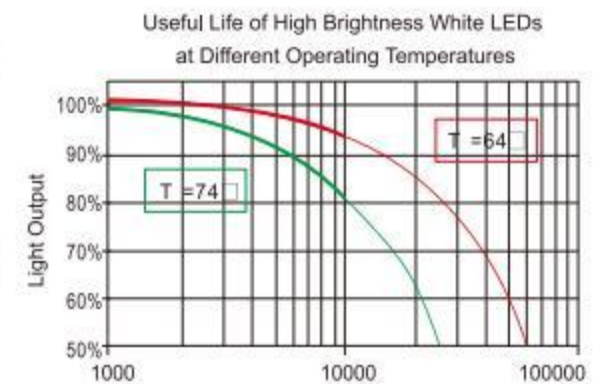

Fire Proof Material 物料防火等級

塑料阻燃等級由 HB, V-2, V-1 向 V-0 逐級遞增。

HB: UL94標準中最低的阻燃等級，要求對於3到13毫米厚的樣品，燃燒速度小於 40毫米每分鐘；小於 3毫米厚的樣品，燃燒速度小於 70毫米每分鐘；或者在 100毫米的標誌前熄滅。

- V-2: 對樣品進行兩次 10秒的燃燒測試後,火焰在 30秒內熄滅,可以引燃 30cm下方的藥棉。
- V-1: 對樣品進行兩次 10秒的燃燒測試後,火焰在 30秒內熄滅,不能引燃 30cm下方的藥棉。
- V-0: 對樣品進行兩次 10秒的燃燒測試後,火焰在 10秒內熄滅,不能有燃燒物掉下。



Plastic flame retardant grades are gradually increased from HB, V-2, V-1 to V-0.

HB: The lowest flame retardant grade in the UL94 standard, Require for 3 to 13mm thick samples with a burning rate of less than 40 mm per minute; less than 3 mm thick samples with a burning rate of less than 70 mm per minute; or stop at 100 mm sign.

V-2: After two 10-second burn tests on the sample, the

flame stops at 30 seconds, would ignite cotton wool below 30cm.

V-1: After two 10-second fire tests on the sample, the flame was at 30 seconds Inside goes out, Would not ignite cotton wool below 30cm.

V-0: After two 10-second burn tests on the sample, the flame stops at 10 seconds, No burning substances should fall off.

Wiring Diagram 接線方案

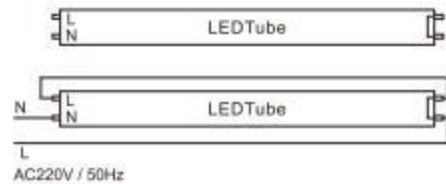

• 新支架內之接線圖

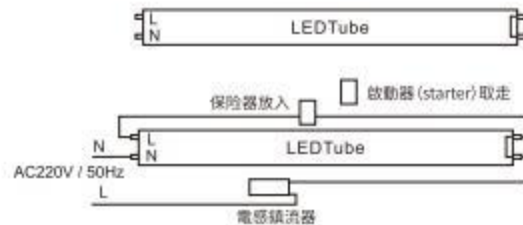

• 舊支架內之接線圖
• 把T8螢光直管及啟動器 (starter) 取走,更換單獨端 T8LED直管電感鎮流器,之後放入保險器,不需要任何線路上改動。

Stroboscopic Suppression 頻閃抑制

理想的光源亮度是鎮流後之直流電壓恆定不變的,這就是理論上的絕對無頻閃。實際上我們平常使用的燈具直流電壓都不會真正的恆定不變,週期的亮度高低變化程度就是頻率。

市面常見LED驅動電路,頻閃深度最大的頻率一般都是100HZ左右。因為PWM高頻是調製在50HZ整流後的電壓

上。實際燈具中,任何的頻率上都有一定的頻閃深度(最高的亮度和最暗的亮度之差)。那麼,這裡就存在一個頻閃深度最大的時候所對應的頻閃頻率。還有就是最大的頻閃深度值。頻閃頻率越高對人的影響越小,頻閃深度越小對人的影響越小,總體來說頻閃深度越小對人降低或消除導致視力疲勞的低頻率光,減輕眼睛負擔,關愛眼睛。

Ideal light source brightness is constant, which is absolute no stroboscopic depth. In fact, the brightness of the lamps we usually install will not be truly stable. The degree of change in the brightness within the period is the frequency.

The common LED drive circuit in the market has the stroboscopic depth at frequency 100 HZ or so. This is because PWM high frequency is modulated on the voltage after 50 HZ rectification. In actual lamps, there will be a certain stroboscopic depth at any frequency. (The difference between the greatest brightest and smallest brightness). Well, there would be the strobe frequency corresponding to the maximum stroboscopic depth, that has the biggest strobe depth value.

The higher the strobe frequency, the smaller the impact is on peoples. As a consulsion, the lower the stroboscopic depth can reduce or eliminate low-frequency light vision fatigue that reduces the burden on the eyes and cares about eye health.



Glare 眩光

是指視野中由於不適宜亮度分佈,是因視野內的亮度大幅超過眼睛所適應,以致引起視覺不舒適和降低物體可見度的視覺條件。視野內產生人眼無法適應之光亮感覺,可能引起厭惡、煩擾、不舒服或視力受損不舒服、甚或喪失明視度。在視野中某一局部地方出現過高的亮度或前後發生過大的亮度變化。

眩光是引起視覺疲勞的重要原因之一。

Refers to the unsuitable brightness distribution in the visual field, resulting in visual discomfort and reduced object visibility Visual conditions. There is a discomfort feeling in the eye vision that a person cannot withstand that would cause disgust, discomfort or even loss of vision. Excessive brightness in a special location of vision, or excessive brightness changes.

Glare is one of the important causes of visual fatigue.

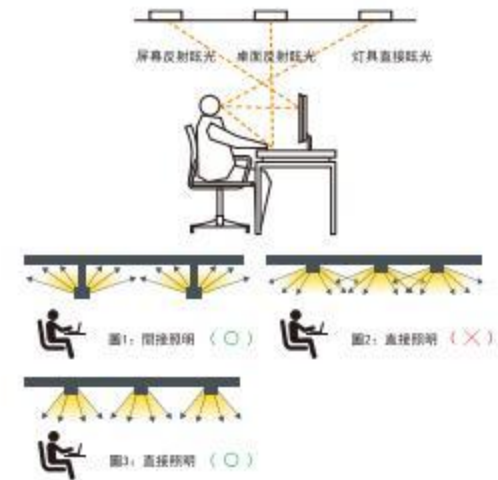

Power Factor 功率因數

功率因數(簡稱PF),是一負載所消耗的有功功率與其視在功率的比值,純電阻負載的視在功率等於有功功率,其功率因數為1。若是由電感、電容及電阻組成的負載,功率因數會小於1。

功率因數在一定程度上反映了發電機容量得以利用的比例,是合理用電的重要指標。功率因數的高低,對於電氣設備的利用率和分析、研究電能消耗等問題都有十分重要的意義。電力公司為了反映較大容量設備及浪費能量的成本,一般會對功率因數較低的工商業用戶以較高的電費費率來計算電費。

Power factor (referred to as PF), is a load consumed by the active power and its apparent power ratio, pure resistance load apparent power is equal to the active power, its power factor is 1. If the load is composed of inductance, capacitance and resistance, the power factor will be less than 1.

Power factor to a certain extent reflects the proportion of generator capacity to be utilized, is an important indicator of rational use of electricity. The level of power factor, for the utilization of electrical

Minimum Allowable Power Factor For LED Lamp With Integrated Driver

Rated Lamp Wattage(LW)	minimum allowable power factor
LW ≤ 5W	0.5
5W < LW ≤ 25W	0.7
LW > 25W	0.9

Information refer to Hong Kong Voluntary Energy Efficiency Labeling for LED Lamp January 2017 EMSD (Electrical and Mechanical Services Department)

equipment and analysis, research and power consumption and other issues are of great significance. In order to reflect the cost of larger capacity equipment and wasted energy, the power company will generally lower power factor of industrial and commercial users to higher rates to calculate the electricity bill, Translated with DeepL.com (free version)

Light source efficiency lm/w (lumen efficiency) 光源效率 lm/w (流明效率)

光源的效率取決於其所發出的光的流明除以起耗電量所得值LED光亮度,並非似功耗(W)度量,而是以流明輸出(lm)來決定。

iLighting LED 流明效益高,更有歐洲A級能源標籤,保證節電環保。

The efficiency of a light source depends on the lumen of the light it emits divided by the power consumption LED brightness is not similar to wattage (W) measurement, but measured in lumens output (lm) Decide.

iLighting LED Lumen has high lumen efficiency, and it also has obtained European A energy label to ensure power saving and environmental protection.

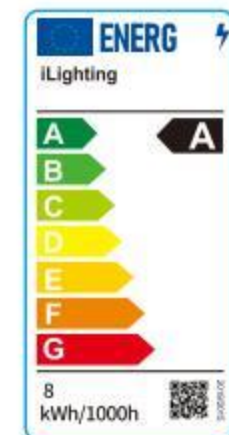

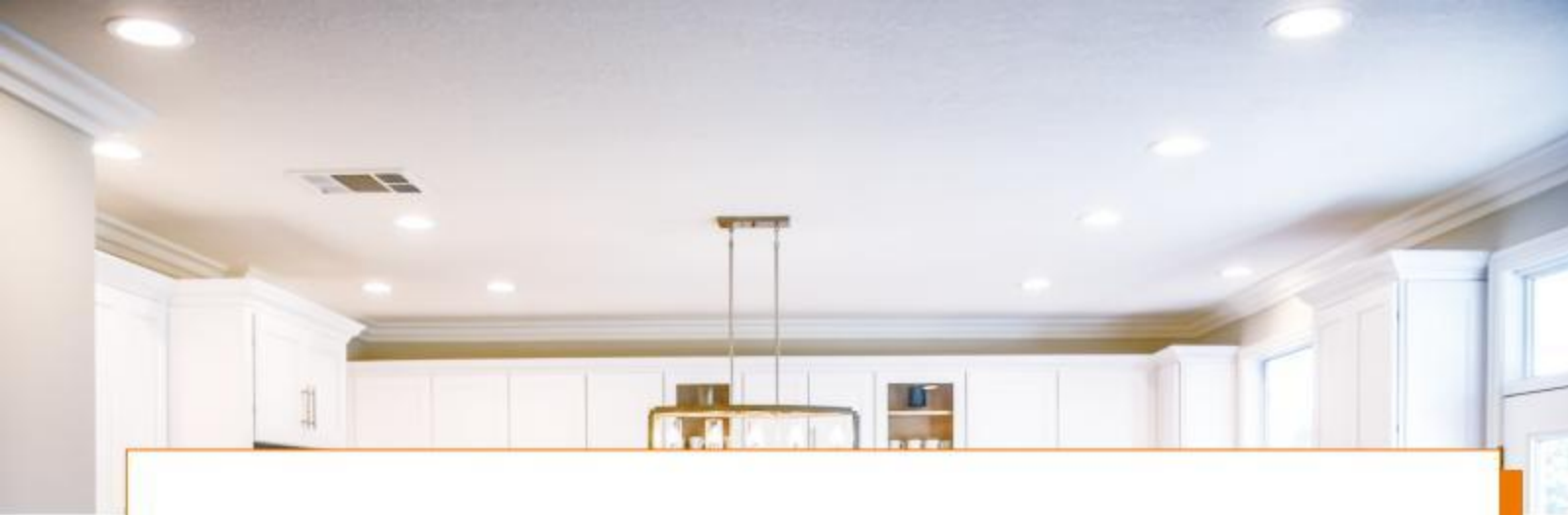

LED International standard for chromaticity difference LED 光源色度差異之國際標準

Chromaticity Tolerances

Quadrangles

- In both Δ CCT and Duv directions
- Approximately equal to 7-step MacAdam ellipses

Nominal CCT	Target CCT and tolerance(K)	Target DUV and tolerance(K)
2700k	2725 ± 145	0.000 ± 0.006
3000k	3045 ± 175	0.000 ± 0.006
3500k	3465 ± 245	0.000 ± 0.006
4000k	3985 ± 275	0.001 ± 0.006
4500k	4503 ± 243	0.001 ± 0.006
5000k	5026 ± 283	0.002 ± 0.006
5700k	5665 ± 355	0.002 ± 0.006
6500k	6530 ± 510	0.003 ± 0.006
Flexible CCT(2700-6500k)	T _P ± Δ T _P	D _v ± 0.006

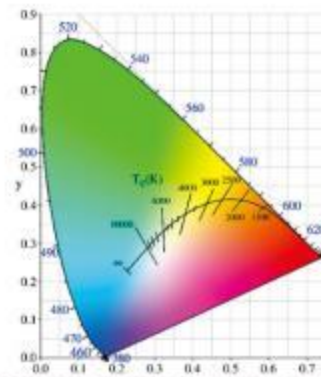

The LED lamp must have one of the rated Correlated Colour Temperatures (CCTs) including 2700K,3000K,3500K,4000K,4500K,5000K,5700K,6500K and flexible CCT consistent with the 7-step chromaticity, quadrangles and Duv tolerances as indicated in Table1.The measured initial CCT and initial DUV shall be within the tolerances of target CCT and target DUV of the selected rated CCT.



Total Harmonic Distortion (THD) 總諧波失真

THD 是驅動電路中的各種非線性元件工作時產生的倍數於電源頻率 (50-60HZ) 的周期性電流電壓干擾, 經驅動電路的輸入端反竄入電網迴路中, 造成電網的工作頻率不純淨 (如 50HZ電網中夾雜著 100HZ、150HZ、200HZ等等的多種雜波電流), 影響其它附近的用電設備, 嚴重的會竄到總電網中破壞電力設備。

例如:各種精密儀器設備、生命維持設備就對使用的電源品質要求很高, 如果使用了諧波大的電網或附近有高諧波的用電設備造成電網諧波過高, 輕則會干擾儀器的精度, 重則可能會導致儀器工作不正常甚至不工作、燒毀等……

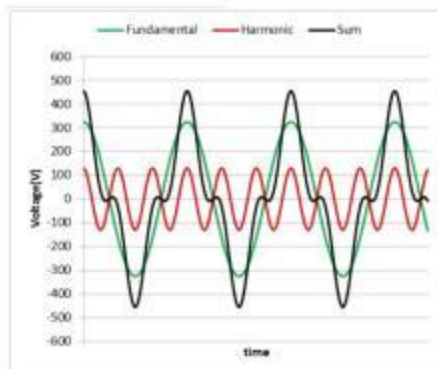

THD's dimming application scheme is the periodic current and voltage interference that multiples of the power supply frequency (50-60HZ) is generated during the operation of various non-linear components in the drive circuit, and then back into the grid circuit through the input of the drive circuit. Causes the impure working frequency of the power grid (for example, a variety of clutter currents of 100HZ, 150HZ, 200HZ, etc. are mixed in the 50HZ power grid), affects other nearby electrical equipment, and can seriously damage the power equipment by channeling into the overall power grid.

For example: various precision instruments and life support equipment have high requirements on the quality of the power supply used. If the network harmonic is too high, it will interfere with the accuracy of the instrument in the light, and it may cause the instrument to work abnormally or even not work, burn out, etc ...



Lux 平均照度

平均照度應用要求照度的定義為被照體單位面積所受的光通量, 其單位為勒克斯(LUX), 每一不同使用目的的場所, 均有其合適的照度來配合實際需要。例如, 一般家庭書房的全般照明照度約為 100 LUX, 閱讀時則需要照度 600 LUX, 此時可用檯燈作為局部照明, 以達到所需照度。照度太低時, 容易導致眼睛疲勞造成近視, 照度太高則過分明亮刺眼, 形成電力浪費。

Lux is defined as the average luminous flux per unit area of the subject, and its unit is lux. Every place with different usage purpose has its own suitable illumination to meet the actual needs. For example, the general illumination of an ordinary home study is about 100 LUX, while reading requires 600 LUX. At this time, a table lamp can be used as local lighting to achieve the required illuminance. When the illuminance is too low, it is easy to cause eye fatigue and myopia, and when the illuminance is too high, it is too bright and dazzling, resulting in waste of electricity.

照度 (LUX)	場所 辦公場所
1500~750	製圖室、設計室、辦公室
750~300	辦公室、電腦室、會議室
300~100	廁所、走廊、樓梯、休息室、其他場所
75~30	太平梯

照度 (LUX)	場所 工廠
3000~1500	組裝作業、檢查、測試、分析、超細微作業、檢查
1500~750	組裝作業、檢查、測試分析、細微作業
750~300	組裝作業、檢查、測試分析、普通作業
300~150	包裝、倉庫

照度 (LUX)	場所 學校
1500~300	精密製圖、精密實驗、圖書館
750~200	教室、圖書館閱覽室、教職員工休息室、體育館
300~75	演講大廳/禮堂、衣物間、走廊、樓梯、休息室
75~30	倉庫、安全梯
10~2	通道 (夜間使用)

Thermal Conductive LED Light Strip

Series Type: P1010



Flick Free
(無閃頻)
保護視力

Features 產品特點 >>

- Size: 9.9 mm (W) x 9.9 mm (H)
- Uniform light emission, 270 degree (3-sectional) lighting output
- SPM Design – power circuit protection to cut off individual LEDs when mal-functioned
- Minimum cutting length < 3mm,
- Thermal conductive plastic to maximize heat dissipation
- Installation in serial for seamless lighting output
- Uniform light emission without LED spot
- Application: Kitchen cabinet, Bathroom cabinet, Closet, Show cabinet, Retail chop, etc



- 尺寸9.9毫米(寬)x9.9毫米(高)
- 最小切割長度<3mm
- 使用SPM設計-電源電路保護,在故障時切斷單個LED
- 採用最佳散熱的導熱塑膠
- 串聯安裝以實現無縫照明輸出
- 發光均勻,無LED光點
- 應用:廚櫃、浴室櫃、衣櫃、展示櫃、零售店等

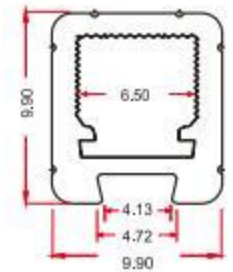

Unit : mm

Specification 產品規格 >>

Model 型號	DC Voltage 電壓	Wattage 功率	Length 長度	Lamp Life 光度壽命	Colour Temp 色溫	Lumen Output 輸出流明	Color Rendering 顯色度	Beam Angle 光澤角度	Operating Temperature 工作溫度
	(V)	(W)	(mm)	(Hrs)	(K)	(Lm/W)	(CRI)	(°)	(°C)
CBL-P1010-S1004-109A	12/24	4	1000	50000	2700/3000/4000/6500	100	>90	270	-20~+45
CBL-P1010-S1008-109A	12/24	8	1000	50000	2700/3000/4000/6500	100	>90	270	-20~+45
CBL-P1010-S1205-109A	12/24	5	1200	50000	2700/3000/4000/6500	100	>90	270	-20~+45
CBL-P1010-S1210-109A	12/24	10	1200	50000	2700/3000/4000/6500	100	>90	270	-20~+45

- Light efficiency (lm/W), Power (W), Color Rendering Index (CRI), Length Can be customized according to customer needs
- Our Standard Power factor (PF) > 0.9 and Total harmonic index THD < 15%, According to customer requirements can produce a lower THD < 10%
- This type of certification is issued by a government-approved laboratory for Safety certification, Fire testing, Restriction of Hazardous Substances (RoHS), Photobiological safety of lamps and lamp systems, (an Exemption Group) and other test certifications to ensure product quality

- 光效 (lm/W)、功率 (W)、顯色指數 (CRI)、長度, 可根據客戶需求定制
- 此型號標準之功率因素 (PF) > 0.9, 總諧波指數 THD < 15%, 可按客戶需要生產低總諧波指數 < 10%
- 此型號認證由可實驗室發出之安全認證消防測試, 環保物料 (RoHS), 光生物安全豁免 Exemption Group 及其它測試, 保證客戶使用更安心滿意

Thermal Conductive LED Strip

LED導熱燈條

Thermal Conductive LED Light Strip

Series Type: P1013



Features 產品特點 >>

- Size: 10.00mm (W) x 13.00mm (H)
- Uniform light emission, 270 degree (3-sectional) lighting output
- SPM Design – power circuit protection to cut off individual LEDs when mal-functioned
- Minimum cutting length < 3mm,
- Thermal conductive plastic to maximize heat dissipation
- Installation in serial for seamless lighting output
- Uniform light emission without LED spot
- Application: Kitchen cabinet, Bathroom cabinet, Closet, Show cabinet, Retail chop, etc



- 尺寸: 10.00毫米(寬)x13.00毫米(高)
- 最小切割長度<3mm
- 使用SPM設計-電源電路保護,在故障時切斷單個LED
- 採用最佳散熱的導熱塑膠
- 串聯安裝以實現無縫照明輸出
- 發光均勻,無LED光點
- 應用:廚櫃、浴室櫃、衣櫃、展示櫃、零售店等



Specification 產品規格 >>

Model 型號	DC Voltage 電壓 (V)	Wattage 功率 (W)	Length 長度 (mm)	Lamp Life 光度壽命 (Hrs)	Colour Temp 色溫 (K)	Lumen Output 輸出流明 (Lm/W)	Color Rendering 顯色度 (CRI)	Beam Angle 光澤角度 (°)	Operating Temperature 工作溫度 (°C)
CBL-P1013-S1004-109A	12/24	4	1000	50000	2700/3000/4000/6500	100	>90	270	-20~+45
CBL-P1013-S1008-109A	12/24	8	1000	50000	2700/3000/4000/6500	100	>90	270	-20~+45
CBL-P1013-S1205-109A	12/24	5	1200	50000	2700/3000/4000/6500	100	>90	270	-20~+45
CBL-P1013-S1210-109A	12/24	10	1200	50000	2700/3000/4000/6500	100	>90	270	-20~+45

- Light efficiency (lm/W), Power (W), Color Rendering Index (CRI), Length Can be customized according to customer needs
- Our Standard Power factor (PF) > 0.9 and Total harmonic index THD < 15%, According to customer requirements can produce a lower THD < 10%
- This type of certification is issued by a government-approved laboratory for Safety certification, Fire testing, Restriction of Hazardous Substances (RoHS), Photobiological safety of lamps and lamp systems. (an Exemption Group) and other test certifications to ensure product quality

- 光效 (lm/W)、功率 (W)、顯色指數 (CRI)、長度, 可根據客戶需求定制
- 此型號標準之功率因素 (PF) > 0.9, 總諧波指數 THD < 15%, 可按客戶需要生產低總諧波指數 < 10%
- 此型號認證由可實驗室發出之安全認證消防測試, 環保物料 (RoHS), 光生物安全豁免 Exemption Group 及其它測試, 保證客戶使用更安心滿意

Thermal Conductive LED Light Strip

Series Type: P0707



Features 產品特點 >>

- Size: 6.99mm (W) x 6.99mm (H)
- Uniform light emission, 270 degree (3-sectional) lighting output
- SPM Design – power circuit protection to cut off individual LEDs when mal-functioned
- Minimum cutting length < 3mm,
- Thermal conductive plastic to maximize heat dissipation
- Installation in serial for seamless lighting output
- Uniform light emission without LED spot
- Application: Kitchen cabinet, Bathroom cabinet, Closet, Show cabinet, Retail chop, etc



- 尺寸: 6.99毫米(寬)x6.99毫米(高)
- 最小切割長度<3mm
- 使用SPM設計-電源電路保護,在故障時切斷單個LED
- 採用最佳散熱的導熱塑膠
- 串聯安裝以實現無縫照明輸出
- 發光均勻,無LED光點
- 應用:廚櫃、浴室櫃、衣櫃、展示櫃、零售店等

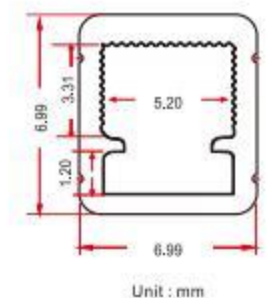

Specification 產品規格 >>

Model 型號	DC Voltage 電壓 (V)	Wattage 功率 (W)	Length 長度 (mm)	Lamp Life 光度壽命 (Hrs)	Colour Temp 色溫 (K)	Lumen Output 輸出流明 (Lm/W)	Color Rendering 顯色度 (CRI)	Beam Angle 光澤角度 (°)	Operating Temperature 工作溫度 (°C)
CBL-P0707-S1004-109A	12/24	4	1000	50000	2700/3000/4000/6500	100	>90	270	-20~+45
CBL-P0707-S1008-109A	12/24	8	1000	50000	2700/3000/4000/6500	100	>90	270	-20~+45
CBL-P0707-S1205-109A	12/24	5	1200	50000	2700/3000/4000/6500	100	>90	270	-20~+45
CBL-P0707-S1210-109A	12/24	10	1200	50000	2700/3000/4000/6500	100	>90	270	-20~+45

- Light efficiency (lm/W), Power (W), Color Rendering Index (CRI), Length Can be customized according to customer needs
- Our Standard Power factor (PF) > 0.9 and Total harmonic index THD < 15%, According to customer requirements can produce a lower THD < 10%
- This type of certification is issued by a government-approved laboratory for Safety certification, Fire testing, Restriction of Hazardous Substances (RoHS), Photobiological safety of lamps and lamp systems. (an Exemption Group) and other test certifications to ensure product quality

- 光效 (lm/W)、功率 (W)、顯色指數 (CRI)、長度, 可根據客戶需求定制
- 此型號標準之功率因素 (PF) > 0.9, 總諧波指數 THD < 15%, 可按客戶需要生產低總諧波指數 < 10%
- 此型號認證由可實驗室發出之安全認證消防測試, 環保物料 (RoHS), 光生物安全豁免 Exemption Group 及其它測試, 保證客戶使用更安心滿意

DMX RGBW LED Cabinet Light Strip

Series Type: P1013-RGB



Features 產品特點 >>

- Size: 10 mm (W) x 13 mm (H)
- Uniform light emission, 270 degree (3-sectional) lighting output
- SPM Design – power circuit protection to cut off individual LEDs when mal-functioned
- Minimum cutting length < 3mm,
- Thermal conductive plastic to maximize heat dissipation
- Installation in serial for seamless lighting output
- Uniform light emission without LED spot
- Control Protocol : DMX512 Control RGB +W
- Application: Show cabinet, Retail chop , etc



- 尺寸: 10毫米(寬)x13毫米(高)
- 最小切割長度 ≤ 3mm
- 使用SPM設計-電源電路保護, 在故障時切斷單個LED
- 採用最佳散熱的導熱塑膠
- 串聯安裝以實現無縫照明輸出
- 發光均勻, 無LED光點
- 控制協議: DMX512控制RGB + W
- 應用: 展示櫃、零售店等

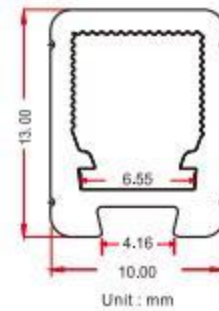

Specification 產品規格 >>

Model 型號	DC Voltage 電壓 (V)	Wattage 功率 (W)	Length 長度 (mm)	Lamp Life 光度壽命 (Hrs)	Colour Temp 色溫 (K)	Lumen Output 輸出流明 (Lm/W)	Color Rendering 顯色度 (CRI)	Beam Angle 光澤角度 (°)	Operating Temperature 工作溫度 (°C)
CBL-P1013-RGB1004-108A	24	4	1000	50000	Mixing Color	100	>80	270	-20~+45
CBL-P1013-RGB1008-108A	24	8	1000	50000	Mixing Color	100	>80	270	-20~+45
CBL-P1013-RGB1205-108A	24	5	1200	50000	Mixing Color	100	>80	270	-20~+45
CBL-P1013-RGB1210-108A	24	10	1200	50000	Mixing Color	100	>80	270	-20~+45

- Light efficiency (lm/W), Power (W), Color Rendering Index (CRI), Length Can be customized according to customer needs
- Power: Cool white-max10.8W/M, RGB Each Color max 3.6W /M
- Our Standard Power factor (PF) > 0.9 and Total harmonic index THD < 15%. According to customer requirements can produce a lower THD < 10%
- This type of certification is issued by a government-approved laboratory for Safety certification, Fire testing, Restriction of Hazardous Substances (RoHS), Photobiological safety of lamps and lamp systems. (an Exemption Group) and other test certifications to ensure product quality
- 光效 (lm/W)、功率 (W)、顯色指數 (CRI)、長度, 可根據客戶需求定制. 此型號標準功率: 冷白色-max10.8W/M, RGB每種顏色最大3.6W/M
- 此型號標準之功率因素 (PF) > 0.9, 總諧波指數 THD < 15%, 可按客戶需要生產低總諧波指數 < 10%
- 此型號認證由可實驗室發出之安全認證消防測試, 環保物料 (RoHS), 光生物安全為 Exemption Group 及其它測試, 保證客戶使用更安心滿意

Aluminum LED Strip

LED铝燈條

Aluminum LED Strip

Series Type: A1013



Features 產品特點 >>

- PC cover : milky
- Size:10 mm (W) x 13 mm (H)
- SPM Design – power circuit protection to cut off individual LEDs when mal-functioned
- Aluminum to maximize heat dissipation
- Installation in serial for seamless lighting output
- Uniform light emission without LED spot
- Application: Kitchen cabinet, Bathroom cabinet ,Closet, Show cabinet, Retail shop,etc



- PC蓋:乳白色
- 尺寸:10毫米(寬)X13毫米(高)
- 使用SPM設計-電源電路保護,在故障時切斷單個LED
- 採用鋁框架使散熱最大化
- 串聯安裝以實現無縫照明輸出
- 發光均勻,無LED光點
- 應用:廚櫃、浴室櫃、壁櫥、展示櫃、零售店等

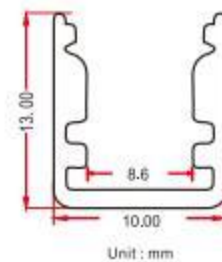

Specification 產品規格 >>

Model 型號	DC Voltage 電壓 (V)	Wattage 功率 (W)	Length 長度 (mm)	Lamp Life 光度壽命 (Hrs)	Colour Temp 色溫 (K)	Lumen Output 輸出流明 (Lm/W)	Color Rendering 顯色度 (CRI)	Beam Angle 光速角度 (°)	Operating Temperature 工作溫度 (°C)
CBL-A1013-S1004-109A	12/24	4	1000	50000	2700/3000/4000/6500	100	>90	120	-20~+45
CBL-A1013-S1008-109A	12/24	8	1000	50000	2700/3000/4000/6500	100	>90	120	-20~+45
CBL-A1013-S1205-109A	12/24	5	1200	50000	2700/3000/4000/6500	100	>90	120	-20~+45
CBL-A1013-S1210-109A	12/24	10	1200	50000	2700/3000/4000/6500	100	>90	120	-20~+45

- Light efficiency (lm/W),Power (W),Color Rendering Index (CRI), Length Can be customized according to customer needs
- Our Standard Power factor (PF) > 0.9 and Total harmonic index THD < 15%, According to customer requirements can produce a lower THD < 10%
- This type of certification is issued by a government-approved laboratory for Safety certification, Fire testing, Restriction of Hazardous Substances(RoHS), Photobiological safety of lamps and lamp systems.(an Exemption Group) and other test certifications to ensure product quality

- 光效(lm/W)、功率(W)、顯色指數(CRI)、長度,可根據客戶需求定制
- 此型號標準之功率因素(PF)>0.9,總諧波指數THD<15%,可按客戶需要生產低總諧波指數<10%
- 此型號認證由可實驗室發出之安全認證消防測試,環保物料(RoHS),光生物安全為Exemption Group及其它測試,保證客戶使用更安心滿意

Aluminum LED Strip

Series Type: A3030



Features 產品特點 >>

- PC cover : milky
- Size:30 mm (W) x 30mm (H)
- SPM Design – power circuit protection to cut off individual LEDs when mal-functioned
- Aluminum to maximize heat dissipation
- Installation in serial for seamless lighting output
- Uniform light emission without LED spot
- Application: Kitchen cabinet, Bathroom cabinet ,Closet, Show cabinet, Retail shop,etc



- PC蓋:乳白色或透明
- 尺寸:30毫米(寬)X30毫米(高)
- 使用SPM設計-電源電路保護,在故障時切斷單個LED
- 採用鋁框架使散熱最大化
- 串聯安裝以實現無縫照明輸出
- 發光均勻,無LED光點
- 應用:廚櫃、浴室櫃、壁櫥、展示櫃、零售店等

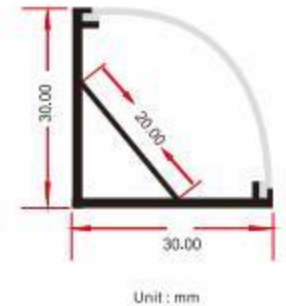

Specification 產品規格 >>

Model 型號	DC Voltage 電壓 (V)	Wattage 功率 (W)	Length 長度 (mm)	Lamp Life 光度壽命 (Hrs)	Colour Temp 色溫 (K)	Lumen Output 輸出流明 (Lm/W)	Color Rendering 顯色度 (CRI)	Beam Angle 光速角度 (°)	Operating Temperature 工作溫度 (°C)
CBL-A3030-S1008-109A	12/24	8	1000	50000	2700/3000/4000/6500	100	>90	120	-20~+45
CBL-A3030-S1010-109A	12/24	10	1000	50000	2700/3000/4000/6500	100	>90	120	-20~+45
CBL-A3030-S1210-109A	12/24	10	1200	50000	2700/3000/4000/6500	100	>90	120	-20~+45
CBL-A3030-S1214-109A	12/24	14	1200	50000	2700/3000/4000/6500	100	>90	120	-20~+45

- Light efficiency (lm/W),Power (W),Color Rendering Index (CRI), Length Can be customized according to customer needs
- Our Standard Power factor (PF) > 0.9 and Total harmonic index THD < 15%, According to customer requirements can produce a lower THD < 10%
- This type of certification is issued by a government-approved laboratory for Safety certification, Fire testing, Restriction of Hazardous Substances(RoHS), Photobiological safety of lamps and lamp systems.(an Exemption Group) and other test certifications to ensure product quality

- 光效(lm/W)、功率(W)、顯色指數(CRI)、長度,可根據客戶需求定制
- 此型號標準之功率因素(PF)>0.9,總諧波指數THD<15%,可按客戶需要生產低總諧波指數<10%
- 此型號認證由可實驗室發出之安全認證消防測試,環保物料(RoHS),光生物安全為Exemption Group及其它測試,保證客戶使用更安心滿意

Aluminum LED Strip

Series Type: A0809



Features 產品特點 >>

- PC cover : milky
- Size: 7.8mm (W) x 9.0 mm (H)
- SPM Design – power circuit protection to cut off individual LEDs when mal-functioned
- Aluminum to maximize heat dissipation
- Installation in serial for seamless lighting output
- Uniform light emission without LED spot
- Application: Kitchen cabinet, Bathroom cabinet ,Closet, Show cabinet, Retail shop,etc



- PC蓋: 乳白色
- 尺寸: 7.8毫米(寬)X9毫米(高)
- 使用SPM設計-電源電路保護, 在故障時切斷單個LED
- 採用鋁框架使散熱最大化
- 串聯安裝以實現無縫照明輸出
- 發光均勻,無LED光點
- 應用: 廚櫃、浴室櫃、壁櫥、展示櫃、零售店等

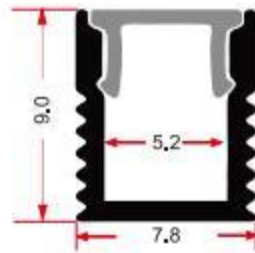

Unit : mm

Specification 產品規格 >>

Model 型號	DC Voltage 電壓 (V)	Wattage 功率 (W)	Length 長度 (mm)	Lamp Life 光度壽命 (Hrs)	Colour Temp 色溫 (K)	Lumen Output 輸出流明 (Lm/W)	Color Rendering 顯色度 (CRI)	Beam Angle 光速角度 (°)	Operating Temperature 工作溫度 (°C)
CBL-A0809-S1004-109A	12/24	4	1000	50000	2700/3000/4000/6500	100	>90	120	-20~+45
CBL-A0809-S1008-109A	12/24	8	1000	50000	2700/3000/4000/6500	100	>90	120	-20~+45
CBL-A0809-S1205-109A	12/24	5	1200	50000	2700/3000/4000/6500	100	>90	120	-20~+45
CBL-A0809-S1210-109A	12/24	10	1200	50000	2700/3000/4000/6500	100	>90	120	-20~+45

- Light efficiency (lm/W), Power (W), Color Rendering Index (CRI), Length Can be customized according to customer needs.
- Our Standard Power factor (PF) > 0.9 and Total harmonic index THD < 15%, According to customer requirements can produce a lower THD < 10%
- This type of certification is issued by a government-approved laboratory for Safety certification, Fire testing, Restriction of Hazardous Substances (RoHS), Photobiological safety of lamps and lamp systems. (an Exemption Group) and other test certifications to ensure product quality

- 光效 (lm/W)、功率 (W)、顯色指數 (CRI)、長度, 可根據客戶需求定制
- 此型號標準之功率因素 (PF) > 0.9, 總諧波指數 THD < 15%, 可按客戶需要生產低總諧波指數 < 10%
- 此型號認證由可實驗室發出之安全認證消防測試, 環保物料 (RoHS), 光生物安全為 Exemption Group 及其它測試, 保證客戶使用更安心滿意

Aluminum LED Strip

Series Type: A1110



Features 產品特點 >>

- PC cover : milky
- Size: 10.8 mm (W) x 10mm (H)
- SPM Design – power circuit protection to cut off individual LEDs when mal-functioned
- Aluminum to maximize heat dissipation
- Installation in serial for seamless lighting output
- Uniform light emission without LED spot
- Application: Kitchen cabinet, Bathroom cabinet ,Closet, Show cabinet, Retail shop,etc



- PC蓋: 乳白色或透明
- 尺寸: 10.8毫米(寬)X10毫米(高)
- 使用SPM設計-電源電路保護, 在故障時切斷單個LED
- 採用鋁框架使散熱最大化
- 串聯安裝以實現無縫照明輸出
- 發光均勻,無LED光點
- 應用: 廚櫃、浴室櫃、壁櫥、展示櫃、零售店等

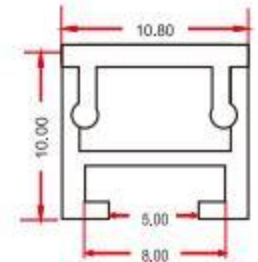

Unit : mm

Specification 產品規格 >>

Model 型號	DC Voltage 電壓 (V)	Wattage 功率 (W)	Length 長度 (mm)	Lamp Life 光度壽命 (Hrs)	Colour Temp 色溫 (K)	Lumen Output 輸出流明 (Lm/W)	Color Rendering 顯色度 (CRI)	Beam Angle 光速角度 (°)	Operating Temperature 工作溫度 (°C)
CBL-A1110-S1004-108A	12/24	4	1000	50000	2700/3000/4000/6500	100	>90	120	-20~+45
CBL-A1110-S1008-109A	12/24	8	1000	50000	2700/3000/4000/6500	100	>90	120	-20~+45
CBL-A1110-S1205-109A	12/24	5	1200	50000	2700/3000/4000/6500	100	>90	120	-20~+45
CBL-A1110-S1210-109A	12/24	10	1200	50000	2700/3000/4000/6500	100	>90	120	-20~+45

- Light efficiency (lm/W), Power (W), Color Rendering Index (CRI), Length Can be customized according to customer needs.
- Our Standard Power factor (PF) > 0.9 and Total harmonic index THD < 15%, According to customer requirements can produce a lower THD < 10%
- This type of certification is issued by a government-approved laboratory for Safety certification, Fire testing, Restriction of Hazardous Substances (RoHS), Photobiological safety of lamps and lamp systems. (an Exemption Group) and other test certifications to ensure product quality

- 光效 (lm/W)、功率 (W)、顯色指數 (CRI)、長度, 可根據客戶需求定制
- 此型號標準之功率因素 (PF) > 0.9, 總諧波指數 THD < 15%, 可按客戶需要生產低總諧波指數 < 10%
- 此型號認證由可實驗室發出之安全認證消防測試, 環保物料 (RoHS), 光生物安全為 Exemption Group 及其它測試, 保證客戶使用更安心滿意

Aluminum LED Strip

Series Type: A1418



Features 產品特點 >>

- PC cover : milky
- Size: 14 mm (W) x 18.5 mm (H)
- SPM Design – power circuit protection to cut off individual LEDs when mal-functioned
- Aluminum to maximize heat dissipation
- Installation in serial for seamless lighting output
- Uniform light emission without LED spot
- Application: Kitchen cabinet, Bathroom cabinet, Closet, Show cabinet, Retail shop, etc



- PC蓋: 乳白色
- 尺寸: 14毫米(寬)X18.5毫米(高)
- 使用SPM設計-電源電路保護, 在故障時切斷單個LED
- 採用鋁框架使散熱最大化
- 串聯安裝以實現無縫照明輸出
- 發光均勻, 無LED光點
- 應用: 廚櫃、浴室櫃、壁櫥、展示櫃、零售店等

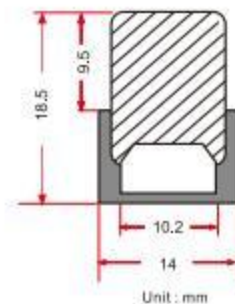

Specification 產品規格 >>

Model 型號	DC Voltage 電壓	Wattage 功率	Length 長度	Lamp Life 光度壽命	Colour Temp 色溫	Lumen Output 輸出流明	Color Rendering 顯色度	Beam Angle 光線角度	Operating Temperature 工作溫度
	(V)	(W)	(mm)	(Hrs)	(K)	(Lm/W)	(CRI)	(°)	(°C)
CBL-A1418-S1004-109A	12/24	4	1000	50000	2700/3000/4000/6500	100	>90	180	-20~+45
CBL-A1418-S1008-109A	12/24	8	1000	50000	2700/3000/4000/6500	100	>90	180	-20~+45
CBL-A1418-S1205-109A	12/24	5	1200	50000	2700/3000/4000/6500	100	>90	180	-20~+45
CBL-A1418-S1210-109A	12/24	10	1200	50000	2700/3000/4000/6500	100	>90	180	-20~+45

- Light efficiency (lm/W), Power (W), Color Rendering Index (CRI), Length Can be customized according to customer needs.
- Our Standard Power factor (PF) > 0.9 and Total harmonic index THD < 15%, According to customer requirements can produce a lower THD < 10%
- This type of certification is issued by a government-approved laboratory for Safety certification, Fire testing, Restriction of Hazardous Substances (RoHS), Photobiological safety of lamps and lamp systems. (an Exemption Group) and other test certifications to ensure product quality

- 光效 (lm/W)、功率 (W)、顯色指數 (CRI)、長度, 可根據客戶需求定制
- 此型號標準之功率因素 (PF) > 0.9, 總諧波指數 THD < 15%, 可按客戶需要生產低總諧波指數 < 10%
- 此型號認證由可實驗室發出之安全認證消防測試, 環保物料 (RoHS), 光生物安全為 Exemption Group 及其它測試, 保證客戶使用更安心滿意

Aluminum LED Strip

Series Type: A1713



Features 產品特點 >>

- PC cover : milky
- Size: 17mm (W) x 13mm (H)
- SPM Design – power circuit protection to cut off individual LEDs when mal-functioned
- Aluminum to maximize heat dissipation
- Installation in serial for seamless lighting output
- Uniform light emission without LED spot
- Application: Kitchen cabinet, Bathroom cabinet, Closet, Show cabinet, Retail shop, etc



- PC蓋: 乳白色或透明
- 尺寸: 17毫米(寬)X13毫米(高)
- 使用SPM設計-電源電路保護, 在故障時切斷單個LED
- 採用鋁框架使散熱最大化
- 串聯安裝以實現無縫照明輸出
- 發光均勻, 無LED光點
- 應用: 廚櫃、浴室櫃、壁櫥、展示櫃、零售店等

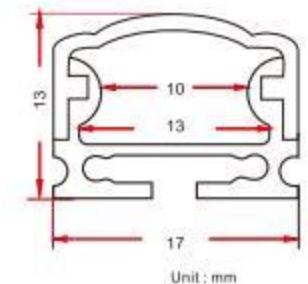

Specification 產品規格 >>

Model 型號	DC Voltage 電壓	Wattage 功率	Length 長度	Lamp Life 光度壽命	Colour Temp 色溫	Lumen Output 輸出流明	Color Rendering 顯色度	Beam Angle 光線角度	Operating Temperature 工作溫度
	(V)	(W)	(mm)	(Hrs)	(K)	(Lm/W)	(CRI)	(°)	(°C)
CBL-A1713-S1004-108A	12/24	4	1000	50000	2700/3000/4000/6500	100	>90	120	-20~+45
CBL-A1713-S1008-109A	12/24	8	1000	50000	2700/3000/4000/6500	100	>90	120	-20~+45
CBL-A1713-S1205-109A	12/24	5	1200	50000	2700/3000/4000/6500	100	>90	120	-20~+45
CBL-A1713-S1210-109A	12/24	10	1200	50000	2700/3000/4000/6500	100	>90	120	-20~+45

- Light efficiency (lm/W), Power (W), Color Rendering Index (CRI), Length Can be customized according to customer needs.
- Our Standard Power factor (PF) > 0.9 and Total harmonic index THD < 15%, According to customer requirements can produce a lower THD < 10%
- This type of certification is issued by a government-approved laboratory for Safety certification, Fire testing, Restriction of Hazardous Substances (RoHS), Photobiological safety of lamps and lamp systems. (an Exemption Group) and other test certifications to ensure product quality

- 光效 (lm/W)、功率 (W)、顯色指數 (CRI)、長度, 可根據客戶需求定制
- 此型號標準之功率因素 (PF) > 0.9, 總諧波指數 THD < 15%, 可按客戶需要生產低總諧波指數 < 10%
- 此型號認證由可實驗室發出之安全認證消防測試, 環保物料 (RoHS), 光生物安全為 Exemption Group 及其它測試, 保證客戶使用更安心滿意

Aluminum LED Strip

Series Type: A2008

Features 產品特點 >>

- PC cover : milky
- Size: 19.8mm (W) x 7.95 mm (H)
- SPM Design – power circuit protection to cut off individual LEDs when mal-functioned
- Aluminum to maximize heat dissipation
- Installation in serial for seamless lighting output
- Uniform light emission without LED spot
- Application: Kitchen cabinet, Bathroom cabinet ,Closet, Show cabinet, Retail shop,etc

- PC蓋: 乳白色
- 尺寸: 19.8毫米(寬)X7.95毫米(高)
- 使用SPM設計-電源電路保護,在故障時切斷單個LED
- 採用鋁框架使散熱最大化
- 串聯安裝以實現無縫照明輸出
- 發光均勻,無LED光點
- 應用: 廚櫃、浴室櫃、壁櫥、展示櫃、零售店等

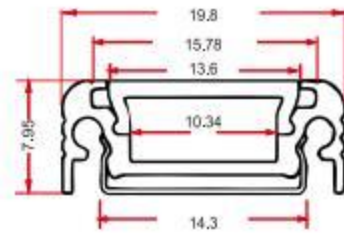

Unit : mm

Specification 產品規格 >>

Model 型號	DC Voltage 電壓	Wattage 功率	Length 長度	Lamp Life 光度壽命	Colour Temp 色溫	Lumen Output 輸出流明	Color Rendering 顯色度	Beam Angle 光束角度	Operating Temperature 工作溫度
	(V)	(W)	(mm)	(Hrs.)	(K)	(Lm/W)	(CRI)	(°)	(°C)
CBL-A2008-S1004-109A	12/24	4	1000	50000	2700/3000/4000/6500	100	>90	120	-20~+45
CBL-A2008-S1008-109A	12/24	8	1000	50000	2700/3000/4000/6500	100	>90	120	-20~+45
CBL-A2008-S1205-109A	12/24	5	1200	50000	2700/3000/4000/6500	100	>90	120	-20~+45
CBL-A2008-S1210-109A	12/24	10	1200	50000	2700/3000/4000/6500	100	>90	120	-20~+45

- Light efficiency (lm/W),Power (W),Color Rendering Index (CRI), Length Can be customized according to customer needs.
- Our Standard Power factor (PF) > 0.9 and Total harmonic index THD < 15%, According to customer requirements can produce a lower THD < 10%
- This type of certification is issued by a government-approved laboratory for Safety certification, Fire testing, Restriction of Hazardous Substances(RoHS), Photobiological safety of lamps and lamp systems.(an Exemption Group) and other test certifications to ensure product quality

- 光效 (lm/W)、功率 (W)、顯色指數 (CRI)、長度,可根據客戶需求定制
- 此型號標準之功率因素 (PF)>0.9,總諧波指數THD<15%,可按客戶需要生產低總諧波指數<10%
- 此型號認證由可實驗室發出之安全認證消防測試,環保物料 (RoHS),光生物安全為Exemption Group及其它測試,保證客戶使用更安心滿意

Aluminum LED Strip

Series Type: A2021

Features 產品特點 >>

- PC cover : milky
- Size: 20mm (W) x 21mm (H)
- SPM Design – power circuit protection to cut off individual LEDs when mal-functioned
- Aluminum to maximize heat dissipation
- Installation in serial for seamless lighting output
- Uniform light emission without LED spot
- Application: Kitchen cabinet, Bathroom cabinet ,Closet, Show cabinet, Retail shop,etc

- PC蓋: 乳白色或透明
- 尺寸: 20毫米(寬)X21毫米(高)
- 使用SPM設計-電源電路保護,在故障時切斷單個LED
- 採用鋁框架使散熱最大化
- 串聯安裝以實現無縫照明輸出
- 發光均勻,無LED光點
- 應用: 廚櫃、浴室櫃、壁櫥、展示櫃、零售店等

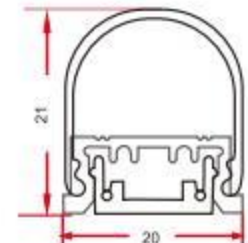

Unit : mm

Specification 產品規格 >>

Model 型號	DC Voltage 電壓	Wattage 功率	Length 長度	Lamp Life 光度壽命	Colour Temp 色溫	Lumen Output 輸出流明	Color Rendering 顯色度	Beam Angle 光束角度	Operating Temperature 工作溫度
	(V)	(W)	(mm)	(Hrs.)	(K)	(Lm/W)	(CRI)	(°)	(°C)
CBL-A2021-S1004-109A	12/24	4	1000	50000	2700/3000/4000/6500	100	>90	270	-20~+45
CBL-A2021-S1008-109A	12/24	8	1000	50000	2700/3000/4000/6500	100	>90	270	-20~+45
CBL-A2021-S1205-109A	12/24	5	1200	50000	2700/3000/4000/6500	100	>90	270	-20~+45
CBL-A2021-S1210-109A	12/24	10	1200	50000	2700/3000/4000/6500	100	>90	270	-20~+45

- Light efficiency (lm/W),Power (W),Color Rendering Index (CRI), Length Can be customized according to customer needs.
- Our Standard Power factor (PF) > 0.9 and Total harmonic index THD < 15%, According to customer requirements can produce a lower THD < 10%
- This type of certification is issued by a government-approved laboratory for Safety certification, Fire testing, Restriction of Hazardous Substances(RoHS), Photobiological safety of lamps and lamp systems.(an Exemption Group) and other test certifications to ensure product quality

- 光效 (lm/W)、功率 (W)、顯色指數 (CRI)、長度,可根據客戶需求定制
- 此型號標準之功率因素 (PF)>0.9,總諧波指數THD<15%,可按客戶需要生產低總諧波指數<10%
- 此型號認證由可實驗室發出之安全認證消防測試,環保物料 (RoHS),光生物安全為Exemption Group及其它測試,保證客戶使用更安心滿意

Aluminum LED Strip - Sensing Switch

Series Type: A1010-S



Features 產品特點 >>

- PC cover : milky
- Size: 10mm (W) x10mm (H)
- LED Cabinet Light Strip & Remote sensing switch
- Aluminum to maximize heat dissipation
- Exceptional even illumination (LED spot not seen)
- Ideal for both direct or indirect light effect
- SPM Design - power circuit protection to cut off individual LEDs when mal-funcioned
- Infrared sensor to detect hand movement at 8cm distance
- Application: Kitchen cabinet, Bathroom cabinet ,Closet, Show cabinet, Retail shop,etc



- PC蓋:乳白色
- 尺寸:10mm(寬)x10mm(高)
- LED櫃燈燈帶和遙感開關
- 鋁制,最大限度地散熱
- 卓越的均勻照明(看不到LED斑點)
- 直接或間接光效果的理想選擇
- SPM設計-電源電路保護,在出現故障時切斷單個LED
- 紅外感測器可檢測8cm距離處的手部運動
- 應用:廚櫃、浴室櫃、壁櫃、展示櫃、零售店等

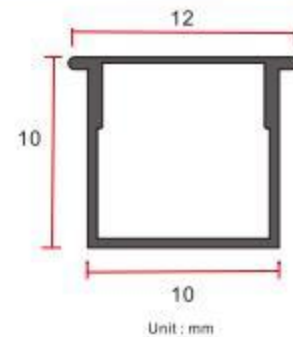

Specification 產品規格 >>

Model 型號	DC Voltage 電壓	Wattage 功率	Length 長度	Lamp Life 光度壽命	Colour Temp 色溫	Lumen Output 輸出流明	Color Rendering 顯色度	Beam Angle 光束角度	Operating Temperature 工作溫度
	(V)	(W)	(mm)	(Hrs)	(K)	(Lm/W)	(CRI)	(°)	(°C)
CBL-A1010-S	Dc24	8	1000	30000	3000/4000/6000	100	≥90	120	-20~+45

- Light efficiency (lm/W),Power (W),Color Rendering Index (CRI), Length Can be customized according to customer needs
- Our Standard Power factor (PF) > 0.9 and Total harmonic index THD < 15%, According to customer requirements can produce a lower THD< 10%
- This type of certification is issued by a government-approved laboratory for Safety certification, Fire testing, Restriction of Hazardous Substances(RoHS), Photobiological safety of lamps and lamp systems.(an Exemption Group) and other test certifications to ensure product quality

- 光效(lm/W)、功率(W)、顯色指數(CRI)、長度,可根據客戶需求定制
- 此型號標準之功率因素(PF)>0.9,總諧波指數THD<15%,可按客戶需要生產低總諧波指數<10%
- 此型號認證由可實驗室發出之安全認證消防測試,環保物料(RoHS),光生物安全為Exemption Group及其它測試,保證客戶使用更安心滿意

Aluminum LED Strip

Series Type:C2310L



Features 產品特點 >>

- Material:Al6063 Aluminum
- Size: 23mm (width) X10mm (height)
- LED cold light source, pure light color, very good display effect
- High light transmission, non-glare, natural light color, uniform light
- High thermal conductivity aluminum-based PCB board, low heat generation and good heat dissipation
- Suitable for cabinet, wardrobe, wine cabinet, display cabinet, lockers and other furniture lighting



- 燈體材料:航空6063鋁
- 尺寸:23毫米(寬)X10毫米(高)
- LED冷光源,光色純正,非常好的展示效果
- 高透光,不刺眼,光色自然,光線均勻
- 採用高導熱鋁基PCB板,發熱量低,散熱好
- 適用於櫥櫃、衣櫃、酒櫃、展示櫃、儲物櫃等家具照明

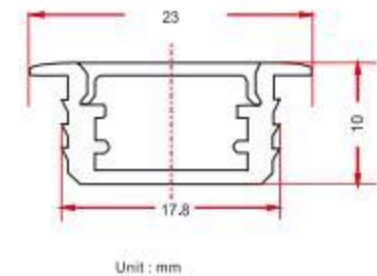

Specification 產品規格 >>

Model 型號	DC Voltage 電壓	Wattage 功率	Length 長度	Lamp Life 光度壽命	Colour Temp 色溫	Lumen Output 輸出流明	Color Rendering 顯色度	Beam Angle 光束角度	Operating Temperature 工作溫度
	(V)	(W)	(mm)	(Hrs)	(K)	(Lm/W)	(CRI)	(°)	(°C)
CBL-C2310L	12	12	1000	30000	3000/4000/6000	100	>90	120	-20~+45

- Light efficiency (lm/W),Power (W),Color Rendering Index (CRI), Length Can be customized according to customer needs
- Our Standard Power factor (PF) > 0.9 and Total harmonic index THD < 15%, According to customer requirements can produce a lower THD< 10%
- This type of certification is issued by a government-approved laboratory for Safety certification, Fire testing, Restriction of Hazardous Substances(RoHS), Photobiological safety of lamps and lamp systems.(an Exemption Group) and other test certifications to ensure product quality

- 光效(lm/W)、功率(W)、顯色指數(CRI)、長度,可根據客戶需求定制
- 此型號標準之功率因素(PF)>0.9,總諧波指數THD<15%,可按客戶需要生產低總諧波指數<10%
- 此型號認證由可實驗室發出之安全認證消防測試,環保物料(RoHS),光生物安全為Exemption Group及其它測試,保證客戶使用更安心滿意

Aluminum LED Strip

Series Type: C2408L



Features 產品特點 >>

- Material: Al6063 Aluminum
- Size: 24.8mm (width) X 8.5mm (height)
- Emitting arc lamp, a larger lighting surface
- Light body is smooth, high brightness, lightweight and thin
- UV resistance does not change yellow, high light transmission
- Suitable for lighting of cabinets, wardrobe, wine cabinets, display cabinets, lockers and other furniture



- 燈體材料: 航空6063鋁
- 尺寸: 24.8毫米(寬)X8.5毫米(高)
- 微弧型發光罩, 亮化面更大
- 燈體光滑, 亮度高, 輕質超薄
- 抗UV紫外線不變黃, 高透光
- 適用於櫥櫃, 衣櫃, 酒櫃, 展示櫃, 儲物櫃等家具照明

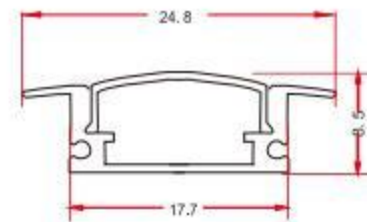

Unit : mm

Specification 產品規格 >>

Model 型號	DC Voltage 電壓	Wattage 功率	Length 長度	Lamp Life 光度壽命	Colour Temp 色溫	Lumen Output 輸出流明	Color Rendering 顯色度	Beam Angle 光透角度	Operating Temperature 工作溫度
	(V)	(W)	(mm)	(Hrs)	(K)	(Lm/W)	(CRI)	(°)	(°C)
CBL-C2408L	12	12	1000	30000	3000/4000/6000	100	>90	120	-20~+45

- Light efficiency (lm/W), Power (W), Color Rendering Index (CRI), Length Can be customized according to customer needs
- Our Standard Power factor (PF) > 0.9 and Total harmonic index THD < 15%, According to customer requirements can produce a lower THD < 10%
- This type of certification is issued by a government-approved laboratory for Safety certification, Fire testing, Restriction of Hazardous Substances (RoHS), Photobiological safety of lamps and lamp systems, (an Exemption Group) and other test certifications to ensure product quality

- 光效 (lm/W)、功率 (W)、顯色指數 (CRI)、長度, 可根據客戶需求定制
- 此型號標準之功率因素 (PF) > 0.9, 總諧波指數 THD < 15%, 可按客戶需要生產低總諧波指數 < 10%
- 此型號認證由可實驗室發出之安全認證消防測試, 環保物料 (RoHS), 光生物安全為 Exemption Group 及其它測試, 保證客戶使用更安心滿意

Aluminum LED Strip

Series Type: C1515L

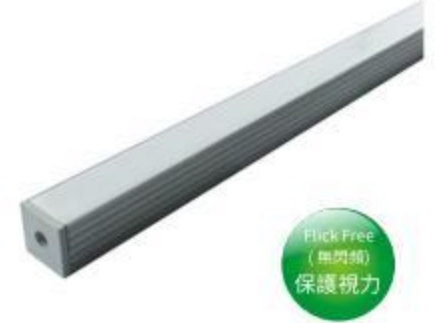

Features 產品特點 >>

- Material: Al6063 Aluminum
- Size: 23mm (width) X 10mm (height)
- A feast of light and vision, feel different beauty
- Easy installation, long life, no light spot design
- High thermal conductivity aluminum-based PCB board, low heat generation, fast heat dissipation
- Suitable for furniture lighting such as cabinets, wardrobes, wine cabinets, display cabinets, storage cabinets, etc.



- 燈體材料: 航空6063鋁
- 尺寸: 14.5毫米(寬)X14.5毫米(高)
- 燈光視覺盛宴, 感受不一樣的美
- 易安裝, 壽命長, 無光點柔和設計
- 採用高導熱鋁基PCB板, 發熱量低, 散熱好
- 適用於櫥櫃, 衣櫃, 酒櫃, 展示櫃, 儲物櫃等家具照明

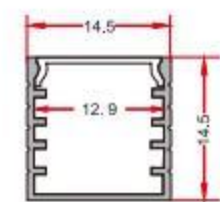

Unit : mm

Specification 產品規格 >>

Model 型號	DC Voltage 電壓	Wattage 功率	Length 長度	Lamp Life 光度壽命	Colour Temp 色溫	Lumen Output 輸出流明	Color Rendering 顯色度	Beam Angle 光透角度	Operating Temperature 工作溫度
	(V)	(W)	(mm)	(Hrs)	(K)	(Lm/W)	(CRI)	(°)	(°C)
CBL-C1515L	12	12	1000	30000	3000/4000/6000	100	>90	120	-20~+45

- Light efficiency (lm/W), Power (W), Color Rendering Index (CRI), Length Can be customized according to customer needs
- Our Standard Power factor (PF) > 0.9 and Total harmonic index THD < 15%, According to customer requirements can produce a lower THD < 10%
- This type of certification is issued by a government-approved laboratory for Safety certification, Fire testing, Restriction of Hazardous Substances (RoHS), Photobiological safety of lamps and lamp systems, (an Exemption Group) and other test certifications to ensure product quality

- 光效 (lm/W)、功率 (W)、顯色指數 (CRI)、長度, 可根據客戶需求定制
- 此型號標準之功率因素 (PF) > 0.9, 總諧波指數 THD < 15%, 可按客戶需要生產低總諧波指數 < 10%
- 此型號認證由可實驗室發出之安全認證消防測試, 環保物料 (RoHS), 光生物安全為 Exemption Group 及其它測試, 保證客戶使用更安心滿意

Aluminum LED Strip

Series Type: C1808L

Features 產品特點 >>

- Material: Al6063 Aluminum
- Size: 24.8mm (width) X 8.5mm (height)
- Necessary hand-scanning induction lamp under the cabinet and hanging cabinet.
- Resists UV rays, does not change yellow, high light transmission, cold resistance, high temperature resistance
- Easy to install, long life, ultra-thin lamp body, simple, smart and stylish
- Suitable for lighting of cabinets, wardrobe, wine cabinets, display cabinets, lockers and other furniture

- 燈體材料: 航空6063鋁
- 尺寸: 24.8毫米(寬)X8.5毫米(高)
- 櫥櫃吊櫃下必備手掃感應燈
- 抗UV紫外線不變黃, 高透光, 耐寒, 耐高溫
- 易安裝, 壽命長, 燈體超薄, 簡約, 智能, 時尚
- 適用於櫥櫃, 衣櫃, 酒櫃, 展示櫃, 儲物櫃等家具照明

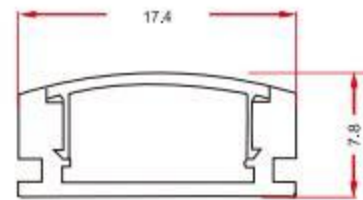

Unit : mm

Specification 產品規格 >>

Model 型號	DC Voltage 電壓	Wattage 功率	Length 長度	Lamp Life 光度壽命	Colour Temp 色溫	Lumen Output 輸出流明	Color Rendering 顯色度	Beam Angle 光束角度	Operating Temperature 工作溫度
	(V)	(W)	(mm)	(Hrs)	(K)	(Lm/W)	(CRI)	(°)	(°C)
CBL-C1808L	12	12	1000	30000	3000/4000/6000	100	>90	120	-20~+45

- Light efficiency (lm/W), Power (W), Color Rendering Index (CRI), Length Can be customized according to customer needs
- Our Standard Power factor (PF) > 0.9 and Total harmonic index THD < 15%, According to customer requirements can produce a lower THD < 10%
- This type of certification is issued by a government-approved laboratory for Safety certification, Fire testing, Restriction of Hazardous Substances (RoHS), Photobiological safety of lamps and lamp systems. (an Exemption Group) and other test certifications to ensure product quality

- 光效 (lm/W)、功率 (W)、顯色指數 (CRI)、長度, 可根據客戶需求定制
- 此型號標準之功率因素 (PF) > 0.9, 總諧波指數 THD < 15%, 可按客戶需要生產低總諧波指數 < 10%
- 此型號認證由可實驗室發出之安全認證消防測試, 環保物料 (RoHS), 光生物安全為 Exemption Group 及其它測試, 保證客戶使用更安心滿意

Aluminum LED Strip

Series Type: C1712

Features 產品特點 >>

- Material: Al6063 Aluminum
- Size: 17.5mm (width) X 11.8mm (height)
- Round plugs, flat plugs, multi-color aluminum, more perfect with furniture decoration
- Even light, no dark area, the first choice for cabinet lighting
- The surface of the whole lamp is anodized, which is more durable, and the lamp body is jagged, which is more secure
- Suitable for furniture lighting such as cabinets, wardrobes, wine cabinets, display cabinets, storage cabinets, etc

- 燈體材料: 航空6063鋁
- 尺寸: 17.5毫米(寬)X11.8毫米(高)
- 圓堵頭, 平堵頭, 多色鋁材, 更完美搭配家具裝飾
- 發光均勻, 無暗區, 櫥內燈光首選
- 整燈表面陽極氧化, 更耐用, 燈體呈鋸齒狀, 安裝更牢固
- 適用於櫥櫃, 衣櫃, 酒櫃, 展示櫃, 儲物櫃等家具照明

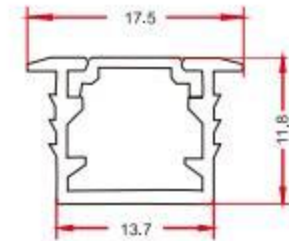

Unit : mm

Specification 產品規格 >>

Model 型號	DC Voltage 電壓	Wattage 功率	Length 長度	Lamp Life 光度壽命	Colour Temp 色溫	Lumen Output 輸出流明	Color Rendering 顯色度	Beam Angle 光束角度	Operating Temperature 工作溫度
	(V)	(W)	(mm)	(Hrs)	(K)	(Lm/W)	(CRI)	(°)	(°C)
CBL-C1712L	12	8	1000	30000	3000/4000/6000	100	>90	120	-20~+45

- Light efficiency (lm/W), Power (W), Color Rendering Index (CRI), Length Can be customized according to customer needs
- Our Standard Power factor (PF) > 0.9 and Total harmonic index THD < 15%, According to customer requirements can produce a lower THD < 10%
- This type of certification is issued by a government-approved laboratory for Safety certification, Fire testing, Restriction of Hazardous Substances (RoHS), Photobiological safety of lamps and lamp systems. (an Exemption Group) and other test certifications to ensure product quality

- 光效 (lm/W)、功率 (W)、顯色指數 (CRI)、長度, 可根據客戶需求定制
- 此型號標準之功率因素 (PF) > 0.9, 總諧波指數 THD < 15%, 可按客戶需要生產低總諧波指數 < 10%
- 此型號認證由可實驗室發出之安全認證消防測試, 環保物料 (RoHS), 光生物安全為 Exemption Group 及其它測試, 保證客戶使用更安心滿意

LED Cabinet UVC Disinfection Light Strip

Series Type: UVC05

Features 產品特點 >>

- Microwave induction lamp strip with UVC disinfection, illumination + disinfection function
 - Automatic light turns on after detecting humans within 3M rang
 - Light turned off after the drawer or closet closed after 90s switch to UV disinfection mode, last for 30 / 90 / 180 mins (user selectable)
 - Switch to illumination mode whenever detecting human, so that the lighting lamp will be on when the person comes, and
 - the sterilization function will be started when the person walks
- It is suitable for furniture lighting such as cabinet, bathroom cabinet, shoe cabinet, wardrobe and drawer

- 帶有微波感應的UVC消毒燈條, 照明+消毒功能
- 探測到3米範圍內的人後, 自動燈亮開啟照明功能
- 抽屜或壁櫥關閉90秒後, 燈關閉切換至紫外線消毒模式, 持續30/90/180分鐘(殺菌時長自主可調)
- 只要檢測到人, 就切換到照明模式, 實現人來照明燈亮, 人走殺菌
- 適用於櫥櫃、浴室櫃、鞋櫃、衣櫃和抽屜等家具照明

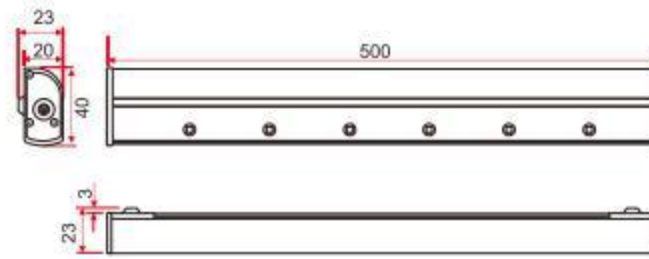
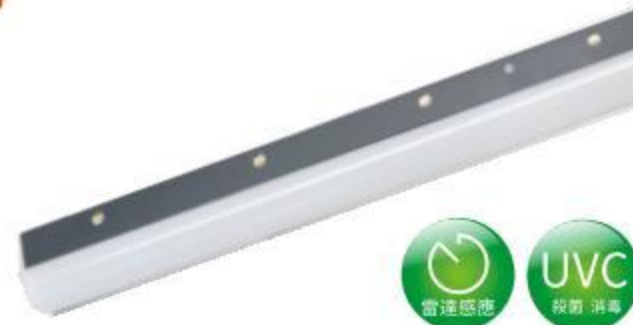

Unit : mm

Specification 產品規格 >>

Model 型號	DC Voltage 電壓	Wattage 照明功率	Wattage 殺菌功率	Length 長度	Lamp Life 光度壽命	Colour Temp 色溫	Lumen Output 輸出流明	Wave Length 波長	Beam Angle 光束角度	Operating Temperature 工作溫度
	(V)	(W)	(W)	(mm)	(Hrs)	(K)	(Lm)	(nm)	(°)	(°C)
CBL-UVC05	24	4	60	500	30000	2700/3000/4000/6000	300	275	120	-20~+45

- Light efficiency (lm/W), Power (W), Color Rendering Index (CRI), Length Can be customized according to customer needs
- Our Standard Power factor (PF) > 0.9 and Total harmonic index THD < 15%, According to customer requirements can produce a lower THD < 10%
- This type of certification is issued by a government-approved laboratory for Safety certification, Fire testing, Restriction of Hazardous Substances (RoHS), Photobiological safety of lamps and lamp systems. (an Exemption Group) and other test certifications to ensure product quality
- 光效 (lm/W)、功率 (W)、顯色指數 (CRI)、長度, 可根據客戶需求定制
- 此型號標準之功率因素 (PF) > 0.9, 總諧波指數 THD < 15%, 可按客戶需要生產低總諧波指數 < 10%
- 此型號認證由可實驗室發出之安全認證消防測試, 環保物料 (RoHS), 光生物安全為 Exemption Group 及其它測試, 保證客戶使用更安心滿意



SOFT LIGHT STRIP
軟光條

5050 Light Belt Monochrome

Series Type: SLB-S



Features 產品特點 >>

- High brightness patch 5050 LED is adopted as the light source with high brightness and wide Angle of view
- The base plate adopts double-sided imported calender copper FPC, which has good folding resistance and strong over-current capacity
- LED Nos: 60PCS/M
- Ultra-low power consumption, only 0.6 watts per unit
- Reasonable optical design, without flicker
- Suitable for indoor installation

- 採用高亮度貼片5050 LED作為高亮度寬視角光源
- 底板採用雙面進口壓延銅FPC, 抗折性好, 過電流能力強
- LED數量: 60PCS/M
- 超低功耗, 每臺僅0.6瓦
- 光學設計合理, 無光斑, 無頻閃
- 適用於室內安裝

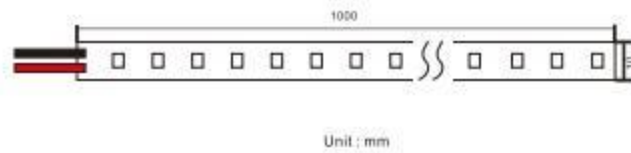
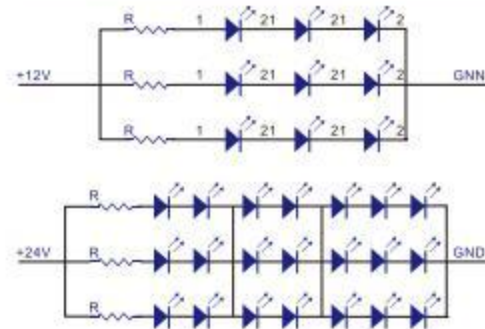

Specification 產品規格 >>

Model 型號	DC Voltage 電壓	Wattage 功率	Lamp Life 光度壽命	Colour Temp 色溫	Lumen Output 輸出流明	Color Rendering 顯色度	Length Per Roll 每卷長度	Size 尺寸
	(V)	(W/M)	(Hrs)	(K)	(Lm/W)	(CRI)	(M)	(mm)
SLB-S5050	12~24	14	50000	3000	80	>80	5	10*6

- Light efficiency (lm/W), Power (W), Color Rendering Index (CRI), Length Can be customized according to customer needs
- Our Standard Power factor (PF) > 0.9 and Total harmonic index THD < 15%, According to customer requirements can produce a lower THD < 10%
- This type of certification is issued by a government-approved laboratory for Safety certification, Fire testing, Restriction of Hazardous Substances (RoHS), Photobiological safety of lamps and lamp systems, (an Exemption Group) and other test certifications to ensure product quality

- 光效 (lm/W)、功率 (W)、顯色指數 (CRI)、長度, 可根據客戶需求定制
- 此型號標準之功率因素 (PF) > 0.9, 總諧波指數 THD < 15%, 可按客戶需要生產低總諧波指數 < 10%
- 此型號認證由可實驗室發出之安全認證消防測試, 環保物料 (RoHS), 光生物安全為 Exemption Group 及其它測試, 保證客戶使用更安心滿意

Glue Waterproof

Series Type: SLB-IP



Features 產品特點 >>

- High brightness patch 2835 LED is adopted as the light source with high brightness and wide Angle of view
- The base plate adopts double-sided imported calender copper PVC
- LED Nos: 120PCS/M
- Beam angle: 120°
- Ultra-low power consumption, only 0.6 watts per unit
- Reasonable optical design, without flicker
- Good waterproof, suitable for indoor and outdoor installation

- 採用高亮度貼片2835 LED作為高亮度寬視角光源
- 底板採用雙面進口壓延銅PVC
- LED數量: 120PCS/M
- 光束角度120度
- 超低功耗, 每臺僅0.6瓦
- 光學設計合理, 無光斑, 無頻閃
- 防水性好, 適用於室內和室外安裝

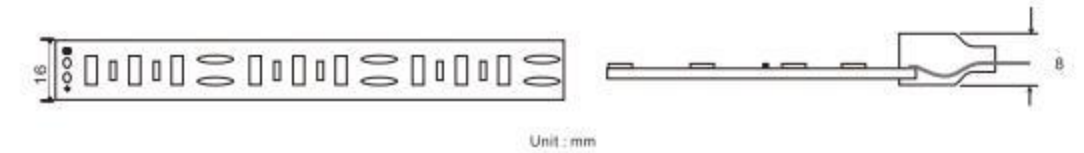

Specification 產品規格 >>

Model 型號	DC Voltage 電壓	Wattage 功率	Lamp Life 光度壽命	Colour Temp 色溫	Lumen Output 輸出流明	Color Rendering 顯色度	Length Per Roll 每卷長度	Size 尺寸
	(V)	(W/M)	(Hrs)	(K)	(Lm/W)	(CRI)	(M)	(mm)
SLB-IP2835	12	14	50000	3000/4000/6500	100	>80	5	16*8

- Light efficiency (lm/W), Power (W), Color Rendering Index (CRI), Length Can be customized according to customer needs
- Our Standard Power factor (PF) > 0.9 and Total harmonic index THD < 15%, According to customer requirements can produce a lower THD < 10%
- This type of certification is issued by a government-approved laboratory for Safety certification, Fire testing, Restriction of Hazardous Substances (RoHS), Photobiological safety of lamps and lamp systems, (an Exemption Group) and other test certifications to ensure product quality

- 光效 (lm/W)、功率 (W)、顯色指數 (CRI)、長度, 可根據客戶需求定制
- 此型號標準之功率因素 (PF) > 0.9, 總諧波指數 THD < 15%, 可按客戶需要生產低總諧波指數 < 10%
- 此型號認證由可實驗室發出之安全認證消防測試, 環保物料 (RoHS), 光生物安全為 Exemption Group 及其它測試, 保證客戶使用更安心滿意

RGB Waterproofing

Series Type: SLB-RGB-IP



Flick Free
(無閃爍)
保護視力

Features 產品特點 >>

- High brightness patch 5050 LED is adopted as the light source with high brightness and wide Angle of view
 - The base plate adopts double-sided imported calender copper PVC, very good resistance
 - LED Nos: 60PCS/M
 - Beam angle:120°
 - Ultra-low power consumption, only 0.6 watts per unit
 - Reasonable optical design, without flicker
 - Easy installation with aluminium trough
 - Good waterproof, suitable for indoor and outdoor installation
- 採用高亮度贴片5050LED作為高亮度寬視角光源
 - 底板採用雙面進口壓PVC,耐性非常好
 - LED數量: 60PCS/M
 - 光束角度: 120°
 - 超低功耗,每臺僅0.6瓦
 - 光學設計合理,無光斑,無頻閃
 - 鋁槽安裝方便
 - 防水性好,適用於室內和室外安裝

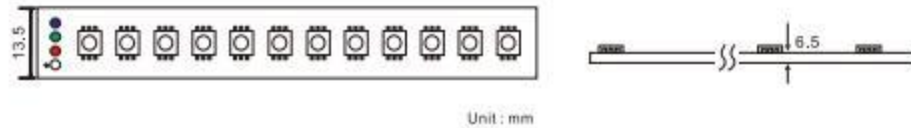

Specification 產品規格 >>

Model 型號	Voltage 電壓	Wattage 功率	Lamp Life 光度壽命	Colour Temp 色溫	Lumen Output 輸出流明	Color Rendering 顯色度	Length Per Roll 每卷長度	Size 尺寸
	(V)	(W/M)	(Hrs)	(K)	(Lm/M)	(CRI)	(M)	(mm)
SLB-RGB-IP5050	220~240	13.5	50000	RGB	100	>80	5	13.5*6.5

- Light efficiency (lm/W), Power (W), Color Rendering Index (CRI), Length Can be customized according to customer needs
 - Our Standard Power factor (PF) > 0.9 and Total harmonic index THD < 15%, According to customer requirements can produce a lower THD < 10%
 - This type of certification is issued by a government-approved laboratory for Safety certification, Fire testing, Restriction of Hazardous Substances (RoHS), Photobiological safety of lamps and lamp systems. (an Exemption Group) and other test certifications to ensure product quality
- 光效 (lm/W)、功率 (W)、顯色指數 (CRI)、長度, 可根據客戶需求定制
 - 此型號標準之功率因素 (PF) > 0.9, 總諧波指數 THD < 15%, 可按客戶需要生產低總諧波指數 < 10%
 - 此型號認證由可實驗室發出之安全認證消防測試, 環保物料 (RoHS), 光生物安全為 Exemption Group 及其它測試, 保證客戶使用更安心滿意

Monochrome/double Row

Series Type: SLB-SD



Flick Free
(無閃爍)
保護視力

Features 產品特點 >>

- High brightness patch 2835 LED is adopted as the light source with high brightness and wide Angle of view
 - The base plate adopts double-sided imported calender copper FPC, which has good folding resistance and strong over-current capacity
 - LED Nos: 120PCS/M
 - Beam angle:120°
 - Ultra-low power consumption, only 0.6 watts per unit
 - Reasonable optical design, without flicker
 - Suitable for indoor installation
- 採用高亮度贴片2835LED作為高亮度寬視角光源
 - 底板採用雙面進口壓延銅FPC, 抗折性好, 過電流能力強
 - LED數量: 120PCS / M
 - 光束角度120度
 - 超低功耗,每臺僅0.6瓦
 - 光學設計合理,無光斑,無頻閃
 - 適用於室內安裝

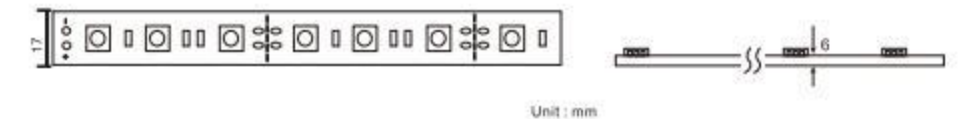

Specification 產品規格 >>

Model 型號	Voltage 電壓	Wattage 功率	Lamp Life 光度壽命	Colour Temp 色溫	Lumen Output 輸出流明	Color Rendering 顯色度	Length Per Roll 每卷長度	Size 尺寸
	(V)	(W/M)	(Hrs)	(K)	(Lm/M)	(CRI)	(M)	(mm)
SLB-SD5630	220~240	14.4	50000	2700-6500	100	>80	5	17*6

- Light efficiency (lm/W), Power (W), Color Rendering Index (CRI), Length Can be customized according to customer needs
 - Our Standard Power factor (PF) > 0.9 and Total harmonic index THD < 15%, According to customer requirements can produce a lower THD < 10%
 - This type of certification is issued by a government-approved laboratory for Safety certification, Fire testing, Restriction of Hazardous Substances (RoHS), Photobiological safety of lamps and lamp systems. (an Exemption Group) and other test certifications to ensure product quality
- 光效 (lm/W)、功率 (W)、顯色指數 (CRI)、長度, 可根據客戶需求定制
 - 此型號標準之功率因素 (PF) > 0.9, 總諧波指數 THD < 15%, 可按客戶需要生產低總諧波指數 < 10%
 - 此型號認證由可實驗室發出之安全認證消防測試, 環保物料 (RoHS), 光生物安全為 Exemption Group 及其它測試, 保證客戶使用更安心滿意

Double Color

Series Type: SLB-D-IP



Features 產品特點 >>

- High brightness patch 2835 LED is adopted as the light source with high brightness and wide Angle of view
- The base plate adopts double-sided imported calender copper PVC, very good resistance
- LED Nos: 120PCS/M
- Beam angle: 120°
- Ultra-low power consumption, only 0.6 watts per unit
- Reasonable optical design, without flicker
- Easy installation with aluminium trough
- Good waterproof, suitable for indoor and outdoor installation
- 採用高亮度貼片2835LED作為高亮度寬視角光源
- 底板採用雙面進口壓PVC, 耐性非常好
- LED數量: 120PCS/M
- 光束角度: 120°
- 超低功耗, 每臺僅0.6瓦
- 光學設計合理, 無光斑, 無頻閃
- 鋁槽安裝方便
- 防水性好, 適用於室內和室外安裝

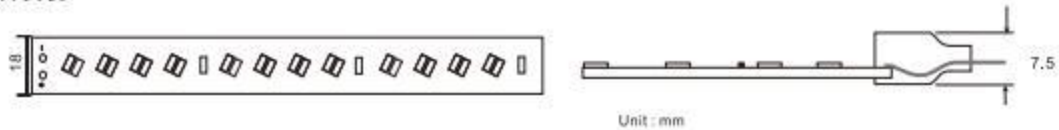

Specification 產品規格 >>

Model 型號	Voltage 電壓	Wattage 功率	Lamp Life 光度壽命	Colour Temp 色溫	Lumen Output 輸出流明	Color Rendering 顯色度	Length Per Roll 每卷長度	Size 尺寸
	(V)	(W/M)	(Hrs)	(K)	(Lm/M)	(CRI)	(M)	(mm)
SLB-DHP5630	220-240	13.5	50000	2700-6500	100-140	>80	5	18*7.5

- Light efficiency (lm/W), Power (W), Color Rendering Index (CRI), Length Can be customized according to customer needs
- Our Standard Power factor (PF) > 0.9 and Total harmonic index THD < 15%, According to customer requirements can produce a lower THD < 10%
- This type of certification is issued by a government-approved laboratory for Safety certification, Fire testing, Restriction of Hazardous Substances (RoHS), Photobiological safety of lamps and lamp systems, (an Exemption Group) and other test certifications to ensure product quality

- 光效 (lm/W)、功率 (W)、顯色指數 (CRI)、長度, 可根據客戶需求定制
- 此型號標準之功率因素 (PF) > 0.9, 總諧波指數 THD < 15%, 可按客戶需要生產低總諧波指數 < 10%
- 此型號認證由可實驗室發出之安全認證消防測試, 環保物料 (RoHS), 光生物安全為 Exemption Group 及其它測試, 保證客戶使用更安心滿意



Transparent waterproof series

透明防水系列



IP65 Hollow Light Belt

Series Type: SLB-T-65

Features 產品特點 >>

- Silica gel material, very good resistance
 - Light transmittance of more than 90%, high tensile strength, tensile rate of 500%
 - High brightness patch 5050 LED is adopted as the light
 - Hollow design, color temperature control within 3%
 - Reasonable optical design, without flicker
 - The luminous surface is arc-shaped, the luminous angle is good, and the plane illuminance curve is good
 - Suitable for indoor or semi-outdoor trough
- 矽膠材質, 耐候性非常好
 - 透光率90%以上, 抗拉强度高, 拉伸速率500%
 - 採用高亮度貼片5050 LED作為光源
 - 鏤空設計, 色溫控制3%以內
 - 光學設計合理, 無光斑, 無頻閃
 - 發光面弧形, 發光角度好, 平面照度曲線好
 - 適用於室內或者半戶外

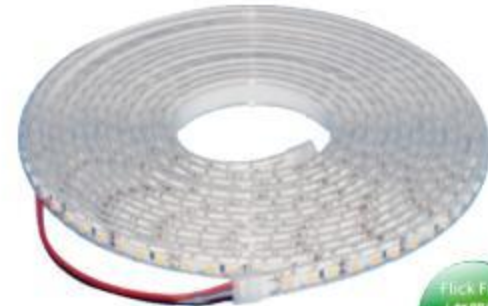

Flick Free
(無閃爍)
保護視力

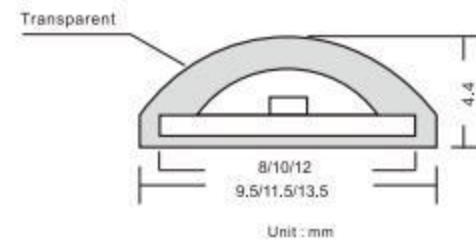
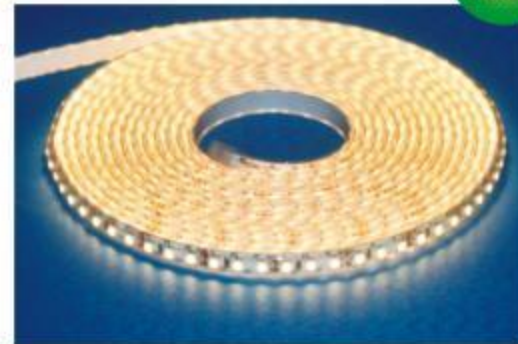

Specification 產品規格 >>

Model 型號	DC Voltage 電壓	Wattage 功率	Lamp Life 光度壽命	Colour Temp 色溫	Lumen Output 輸出流明	Total Lumen 總流明	Color Rendering 顯色度	Suitable Plate Width 適宜板寬	Size 尺寸
	(V)	(W)	(Hrs)	(K)	(Lm/W)	(Lm/M)	(CRI)	(mm)	(mm)
SLB-T1004-65	12/24	9.6/4.8	50000	3000	100	960 / 480	>80	8	9.5*4.4
SLB-T1204-65	12/24	9.6/4.8	50000	3000	100	960 / 480	>80	10	11.5*4.4
SLB-T1404-65	12/24	9.6/4.8	50000	3000	100	960 / 480	>80	12	13.5*4.4

- Light efficiency (lm/W), Power (W), Color Rendering Index (CRI), Length can be customized according to customer needs
- Our Standard Power factor (PF) > 0.9 and Total harmonic index THD < 15%, According to customer requirements can produce a lower THD < 10%
- This type of certification is issued by a government-approved laboratory for Safety certification, Fire testing, Restriction of Hazardous Substances (RoHS), Photobiological safety of lamps and lamp systems, (an Exemption Group) and other test certifications to ensure product quality

- 光效 (lm/W)、功率 (W)、顯色指數 (CRI)、長度可根據客戶需求定制
- 此型號標準之功率因素 (PF) > 0.9, 總諧波指數 THD < 15%, 可按客戶需要生產低總諧波指數 < 10%
- 此型號認證由可實驗室發出之安全認證消防測試, 環保物料 (RoHS), 光生物安全為 Exemption Group 及其它測試, 保證客戶使用更安心滿意

IP67 Hollow Light Belt

Series Type: SLB-T-67

Features 產品特點 >>

- Silica gel material, very good resistance
 - Light transmittance of more than 90%, high tensile strength, tensile rate of 500%
 - High brightness patch 5050 LED is adopted as the light
 - Hollow design, better heat dissipation
 - Reasonable optical design, without flicker
 - The luminous surface is square, the luminous angle is good, and the plane illuminance curve is good
 - Suitable for indoor or outdoor non-deep water
- 矽膠材質, 耐候性常好
 - 透光率90%以上, 抗拉强度高, 拉伸速率500%
 - 採用高亮度貼片5050 LED作為光源
 - 鏤空設計, 散熱性好
 - 光學設計合理, 無光斑, 無頻閃
 - 發光面正面, 發光角度好, 平面照度曲線好
 - 適用於室內或者室外非深水處



Flick Free
(無閃爍)
保護視力

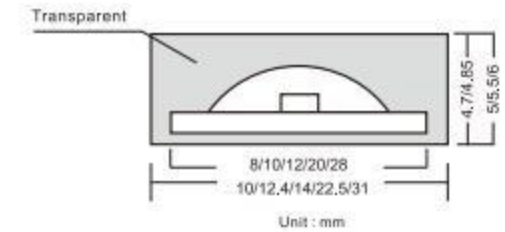

Specification 產品規格 >>

Model 型號	DC Voltage 電壓	Wattage 功率	Lamp Life 光度壽命	Colour Temp 色溫	Lumen Output 輸出流明	Total Lumen 總流明	Color Rendering 顯色度	Suitable Plate Width 適宜板寬	Size 尺寸
	(V)	(W)	(Hrs)	(K)	(Lm/W)	(Lm/M)	(CRI)	(mm)	(mm)
SLB-T1005-67	12/24	9.6/4.8	50000	3000	100	960 / 480	>80	8	10*4.7
SLB-T1205-67	12/24	9.6/4.8	50000	3000	100	960 / 480	>80	10	12*4.85
SLB-T1405-67	12/24	9.6/4.8	50000	3000	100	960 / 480	>80	12	14*5
SLB-T2206-67	12/24	9.6/4.8	50000	3000	100	960 / 480	>80	20	22*5.5
SLB-T3106-67	12/24	9.6/4.8	50000	3000	100	960 / 480	>80	28	31*6

- Light efficiency (lm/W), Power (W), Color Rendering Index (CRI), Length can be customized according to customer needs
- Our Standard Power factor (PF) > 0.9 and Total harmonic index THD < 15%, According to customer requirements can produce a lower THD < 10%
- This type of certification is issued by a government-approved laboratory for Safety certification, Fire testing, Restriction of Hazardous Substances (RoHS), Photobiological safety of lamps and lamp systems, (an Exemption Group) and other test certifications to ensure product quality

- 光效 (lm/W)、功率 (W)、顯色指數 (CRI)、長度可根據客戶需求定制
- 此型號標準之功率因素 (PF) > 0.9, 總諧波指數 THD < 15%, 可按客戶需要生產低總諧波指數 < 10%
- 此型號認證由可實驗室發出之安全認證消防測試, 環保物料 (RoHS), 光生物安全為 Exemption Group 及其它測試, 保證客戶使用更安心滿意

IP68 Solid Light Strip

Series Type: SLB-T-68

Features 產品特點 >>

- Silica gel material, very good resistance
- Light transmittance of more than 90%, high tensile strength, tensile rate of 500%
- High brightness patch 5050 LED is adopted as the light
- Extrusion solid design, plug molding integrated molding
- Reasonable optical design, without flicker
- The light-emitting surface is square, the luminous angle is good, and the plane illuminance curve is good
- Suitable for indoor or outdoor non-deep water

- 矽膠材質, 耐候性非常好
- 透光率90%以上, 抗拉强度高, 拉伸速率500%
- 採用高亮度貼片5050 LED作為光源
- 擠出實心設計, 堵頭模壓一體成型
- 光學設計合理, 無光斑, 無頻閃
- 發光面方形, 發光角度好, 平面照度曲線好
- 適用於室內或者室外非深水處

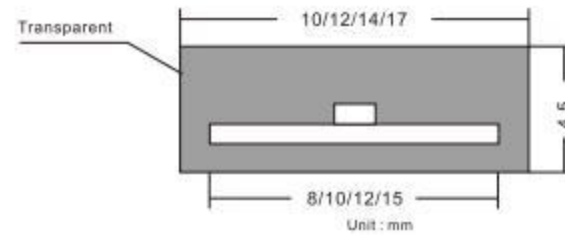

Specification 產品規格 >>

Model 型號	DC Voltage 電壓 (V)	Wattage 功率 (W/M)	Lamp Life 光度壽命 (Hrs)	Colour Temp 色溫 (K)	Lumen Output 輸出流明 (Lm/M)	Total Lumen 總流明 (Lm/M)	Color Rendering 顯色度 (CRI)	Suitable Plate Width 適宜板寬 (mm)	Size 尺寸 (mm)
SLB-T1004-68	12/24	9.6/4.8	50000	3000	100	960 / 480	>80	8	10*4.5
SLB-T1204-68	12/24	9.6/4.8	50000	3000	100	960 / 480	>80	10	12*4.5
SLB-T1404-68	12/24	9.6/4.8	50000	RGB	100	960 / 480	>80	12	14*4.5
SLB-T1704-68	12/24	9.6/4.8	50000	RGB	100	960 / 480	>80	15	17*4.5

- Light efficiency (lm/W), Power (W), Color Rendering Index (CRI), Length Can be customized according to customer needs
- Our Standard Power factor (PF) > 0.9 and Total harmonic index THD < 15%, According to customer requirements can produce a lower THD < 10%
- This type of certification is issued by a government-approved laboratory for Safety certification, Fire testing, Restriction of Hazardous Substances (RoHS), Photobiological safety of lamps and lamp systems, (an Exemption Group) and other test certifications to ensure product quality

- 光效 (lm/W)、功率 (W)、顯色指數 (CRI)、長度可根據客戶需求定制
- 此型號標準之功率因素 (PF) > 0.9, 總諧波指數 THD < 15%, 可按客戶需要生產低總諧波指數 < 10%
- 此型號認證由可實驗室發出之安全認證消防測試, 環保物料 (RoHS), 光生物安全為 Exemption Group 及其它測試, 保證客戶使用更安心滿意

Neon Light STRIP

霓虹燈帶



IP Series Neon Light

Series Type: SLB-NL-IP



Flick Free
(無閃頻)
保護視力

Features 產品特點 >>

- High brightness patch 2835 LED is adopted as the light source with high brightness and wide Angle of view
- The base plate adopts double-sided imported calender copper PVC, very good resistance
- LED Nos: 120PCS/M
- Beam angle:120°
- Ultra-low power consumption, only 0.6 watts per unit
- Reasonable optical design, without flicker
- Easy installation with aluminium trough
- Good waterproof, suitable for indoor and outdoor installation



- 採用高亮度貼片2835LED作為高亮度寬視角光源
- 底板採用雙面進口壓PVC,耐候性非常好
- LED數量: 120PCS/M
- 光束角度: 120°
- 超低功耗, 每臺僅0.6瓦
- 光學設計合理, 無光斑, 無頻閃
- 鋁槽安裝方便
- 防水性好, 適用於室內和室外安裝



Unit: mm

Specification 產品規格 >>

Model 型號	Voltage 電壓	Wattage 功率	Lamp Life 光度壽命	Colour Temp 色溫	Lumen Output 輸出流明	Total Lumen 總流明	Color Rendering 顯色度	Waterproof Grade 防水等級	Size 尺寸
	(V)	(W)	(Hrs)	(K)	(Lm/W)	(Lm/M)	(CRI)	(IP)	(mm)
SLB-NL-IP2835	220-240	12	50000	2700-6500	100	1200	>80	65	1000*10*20

- Light efficiency (lm/W), Power (W), Color Rendering Index (CRI), Length Can be customized according to customer needs
- Our Standard Power factor (PF) > 0.9 and Total harmonic index THD < 15%, According to customer requirements can produce a lower THD < 10%
- This type of certification is issued by a government-approved laboratory for Safety certification, Fire testing, Restriction of Hazardous Substances (RoHS), Photobiological safety of lamps and lamp systems. (an Exemption Group) and other test certifications to ensure product quality

- 光效 (lm/W)、功率 (W)、顯色指數 (CRI)、長度, 可根據客戶需求定制
- 此型號標準之功率因素 (PF) > 0.9, 總諧波指數 THD < 15%, 可按客戶需要生產低總諧波指數 < 10%
- 此型號認證由可實驗室發出之安全認證消防測試, 環保物料 (RoHS), 光生物安全為 Exemption Group 及其它測試, 保證客戶使用更安心滿意

T5 Series Neon Light

Series Type: SLB-NL-T5



Flick Free
(無閃頻)
保護視力

Features 產品特點 >>

- High brightness patch 2835 LED is adopted as the light source with high brightness and wide Angle of view
- Silicone material, very good weather resistance
- LED Nos: 120PCS/M, side glow
- Hollow design, good heat dissipation
- 5 * 10 three sided light blocking, light emitting flat head, 5 * 13 three sided light blocking, light emitting mushroom head, all can be cut arbitrarily
- The special design of the plug is convenient for shape docking, and there is no dark area in docking
- The light strip is very soft, convenient for packaging and any shape
- Suitable for indoor and outdoor

- 採用高亮度貼片2835LED作為高亮度寬視角光源
- 硅膠材質, 耐候性非常好
- LED數量: 120PCS/M, 側面發光
- 鏤空設計, 散熱性好
- 5*10三面擋光, 發光面平頭, 5*13三面擋光, 發光面蘑菇頭, 均可以任意裁剪
- 堵頭特殊設計, 方便造型對接, 對接無暗區
- 燈帶非常柔軟, 方便包裝以及任意造型
- 适用于室內室外

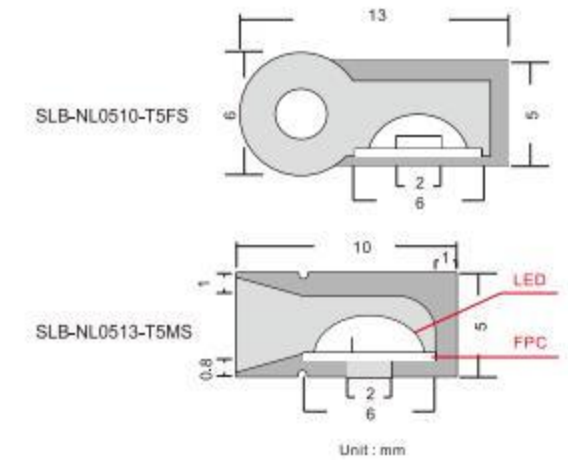

Unit: mm

Specification 產品規格 >>

Model 型號	DC Voltage 電壓	Wattage 功率	Lamp Life 光度壽命	Colour Temp 色溫	Lumen Output 輸出流明	Total Lumen 總流明	Color Rendering 顯色度	Waterproof Grade 防水等級	Size 尺寸
	(V)	(W)	(Hrs)	(K)	(Lm/W)	(Lm/M)	(CRI)	(IP)	(mm)
SLB-NL0510-T5FS	12/24	9.6/4.8	50000	3000	100	960 / 480	>80	IP67	5*10
SLB-NL0513-T5MS	12/24	9.6/4.8	50000	3000	100	960 / 480	>80	IP67	5*13

- Light efficiency (lm/W), Power (W), Color Rendering Index (CRI), Length Can be customized according to customer needs
- Our Standard Power factor (PF) > 0.9 and Total harmonic index THD < 15%, According to customer requirements can produce a lower THD < 10%
- This type of certification is issued by a government-approved laboratory for Safety certification, Fire testing, Restriction of Hazardous Substances (RoHS), Photobiological safety of lamps and lamp systems. (an Exemption Group) and other test certifications to ensure product quality

- 光效 (lm/W)、功率 (W)、顯色指數 (CRI)、長度, 可根據客戶需求定制
- 此型號標準之功率因素 (PF) > 0.9, 總諧波指數 THD < 15%, 可按客戶需要生產低總諧波指數 < 10%
- 此型號認證由可實驗室發出之安全認證消防測試, 環保物料 (RoHS), 光生物安全為 Exemption Group 及其它測試, 保證客戶使用更安心滿意

T6 Series Neon Light

Series Type: SLB-NL-T6

Features 產品特點 >>

- High brightness patch 2835 LED is adopted as the light source with high brightness and wide Angle of view
- Silicone material, very good weather resistance
- LED Nos: 120PCS/M, side glow
- Hollow design, good heat dissipation
- 6 * 12 three sided light blocking, light emitting flat head, 6*13 three sided light blocking, light emitting mushroom head, all can be cut arbitrarily
- The special design of the plug is convenient for shape docking, and there is no dark area in docking
- The light strip is very soft, convenient for packaging and any shape Suitable for indoor and outdoor

- 採用高亮度貼片2835LED作為高亮度寬視角光源
- LED數量: 120PCS/M, 側面發光
- 硅胶材質, 耐候性非常好
- 鏤空設計, 散熱性好
- 6*12三面擋光, 發光面平頭, 6*13三面擋光, 發光面蘑菇頭, 均可以任意裁剪
- 堵頭特殊設計, 方便造型對接, 對接無暗區
- 燈帶非常柔軟, 方便包裝以及任意造型
- 适用于室內室外

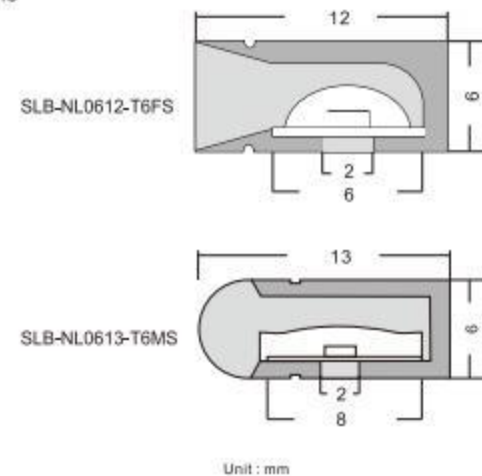
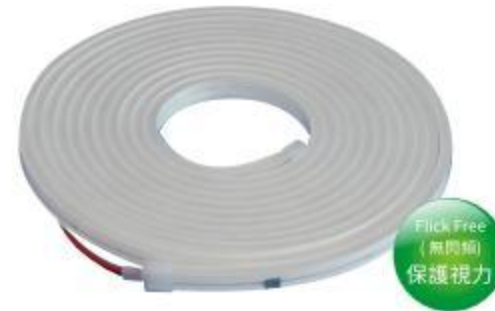

Specification 產品規格 >>

Model 型號	DC Voltage 電壓	Wattage 功率	Lamp Life 光度壽命	Colour Temp 色溫	Lumen Output 輸出流明	Total Lumen 總流明	Color Rendering 顯色度	Waterproof Grade 防水等級	Size 尺寸
	(V)	(W/M)	(Hrs)	(K)	(Lm/M)	(Lm/M)	(CRI)	(IP)	(mm)
SLB-NL0612-T6FS	12/24	9.6/4.8	50000	3000	100	960 / 480	>80	IP67	6*12
SLB-NL0613-T6MS	12/24	9.6/4.8	50000	3000	100	960 / 480	>80	IP67	6*13

- Light efficiency (lm/W), Power (W), Color Rendering Index (CRI), Length can be customized according to customer needs
- Our Standard Power factor (PF) > 0.9 and Total harmonic index THD < 15%, According to customer requirements can produce a lower THD < 10%
- This type of certification is issued by a government-approved laboratory for Safety certification, Fire testing, Restriction of Hazardous Substances (RoHS), Photobiological safety of lamps and lamp systems. (an Exemption Group) and other test certifications to ensure product quality
- 光效 (lm/W)、功率 (W)、顯色指數 (CRI)、長度可根據客戶需求定制
- 此型號標準之功率因素 (PF) > 0.9, 總諧波指數 THD < 15%, 可按客戶需要生產低總諧波指數 < 10%
- 此型號認證由可實驗室發出之安全認證消防測試, 環保物料 (RoHS), 光生物安全為 Exemption Group 及其它測試, 保證客戶使用更安心滿意

T7 Series Neon Light

Series Type: SLB-NL-T7

Features 產品特點 >>

- High brightness patch 2835 LED is adopted as the light source with high brightness and wide Angle of view
- Silicone material, very good weather resistance
- LED Nos: 120PCS/M, side glow
- Hollow design, good heat dissipation
- 7 * 14 three sided light blocking, illuminated mushroom head, can be cut freely
- The special design of the plug is convenient for shape docking, and there is no dark area in docking
- The light strip is very soft, convenient for packaging and any shape
- Suitable for indoor and outdoor

- 採用高亮度貼片2835LED作為高亮度寬視角光源
- 硅胶材質, 耐候性非常好
- LED數量: 120PCS/M, 側面發光
- 鏤空設計, 散熱性好
- 7*14三面擋光, 發光面蘑菇頭, 可以任意裁剪
- 堵頭特殊設計, 方便造型對接, 對接無暗區
- 燈帶非常柔軟, 方便包裝以及任意造型
- 适用于室內室外

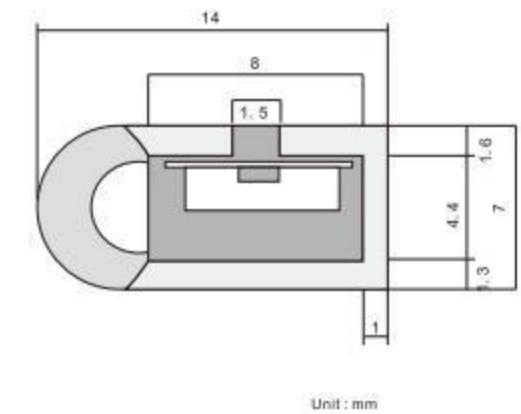

Specification 產品規格 >>

Model 型號	DC Voltage 電壓	Wattage 功率	Lamp Life 光度壽命	Colour Temp 色溫	Lumen Output 輸出流明	Total Lumen 總流明	Color Rendering 顯色度	Waterproof Grade 防水等級	Size 尺寸
	(V)	(W/M)	(Hrs)	(K)	(Lm/M)	(Lm/M)	(CRI)	(IP)	(mm)
SLB-NL0714-T7MS	12/24	9.6/4.8	50000	3000	100	960 / 480	>80	IP67	7*14

- Light efficiency (lm/W), Power (W), Color Rendering Index (CRI), Length can be customized according to customer needs
- Our Standard Power factor (PF) > 0.9 and Total harmonic index THD < 15%, According to customer requirements can produce a lower THD < 10%
- This type of certification is issued by a government-approved laboratory for Safety certification, Fire testing, Restriction of Hazardous Substances (RoHS), Photobiological safety of lamps and lamp systems. (an Exemption Group) and other test certifications to ensure product quality
- 光效 (lm/W)、功率 (W)、顯色指數 (CRI)、長度可根據客戶需求定制
- 此型號標準之功率因素 (PF) > 0.9, 總諧波指數 THD < 15%, 可按客戶需要生產低總諧波指數 < 10%
- 此型號認證由可實驗室發出之安全認證消防測試, 環保物料 (RoHS), 光生物安全為 Exemption Group 及其它測試, 保證客戶使用更安心滿意

T8 Series Neon Light

Series Type: SLB-NL-T8

Features 產品特點 >>

- High brightness patch 2835 LED is adopted as the light source with high brightness and wide Angle of view
- Silicone material, very good weather resistance
- LED Nos: 72PCS/M, side glow
- Hollow design, good heat dissipation
- 8*15 three sided light blocking, light emitting flat head, 8*16 three sided light blocking, light emitting mushroom head, all can be cut arbitrarily
- The special design of the plug is convenient for shape docking, and there is no dark area in docking
- The light strip is very soft, convenient for packaging and any shape
- Suitable for indoor and outdoor

- 採用高亮度貼片2835LED作為高亮度寬視角光源
- LED數量: 72PCS/M, 側面發光
- 矽膠材質, 耐候性非常好
- 鏤空設計, 散熱性好
- 8*15三面擋光, 發光面平頭, 8*16三面擋光, 發光面蘑菇頭, 均可以任意裁剪
- 堵頭特殊設計, 方便造型對接, 對接無暗區
- 燈帶非常柔軟, 方便包裝以及任意造型
- 适用于室內室外

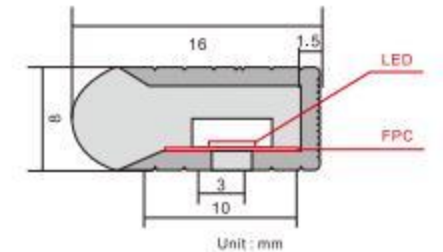
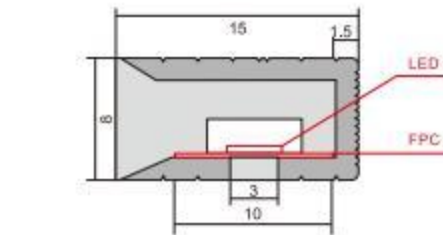

Specification 產品規格 >>

Model 型號	DC Voltage 電壓	Wattage 功率	Lamp Life 光度壽命	Colour Temp 色溫	Lumen Output 輸出流明	Total Lumen 總流明	Color Rendering 顯色度	Waterproof Grade 防水等級	Size 尺寸
	(V)	(W/M)	(Hrs)	(K)	(Lm/M)	(Lm/M)	(CRI)	(IP)	(mm)
SLB-NL0815-T8FS	12/24	9.6/4.8	50000	3000	100	960 / 480	>80	IP67	8*15
SLB-NL0816-T8MS	12/24	9.6/4.8	50000	3000	100	960 / 480	>80	IP67	8*16

- Light efficiency (lm/W), Power (W), Color Rendering Index (CRI), Length can be customized according to customer needs
- Our Standard Power factor (PF) > 0.9 and Total harmonic index THD < 15%, According to customer requirements can produce a lower THD < 10%
- This type of certification is issued by a government-approved laboratory for Safety certification, Fire testing, Restriction of Hazardous Substances (RoHS), Photobiological safety of lamps and lamp systems, (an Exemption Group) and other test certifications to ensure product quality
- 光效 (lm/W)、功率 (W)、顯色指數 (CRI)、長度可根據客戶需求定制
- 此型號標準之功率因素 (PF) > 0.9, 總諧波指數 THD < 15%, 可按客戶需要生產低總諧波指數 < 10%
- 此型號認證由可實驗室發出之安全認證消防測試, 環保物料 (RoHS), 光生物安全為 Exemption Group 及其它測試, 保證客戶使用更安心滿意

High efficiency light strip

Series Type: SLB-NL-H

Features 產品特點 >>

- High brightness patch 2835 LED is adopted as the light source with high brightness and wide Angle of view
- Silicone material, very good weather resistance
- LED Nos: 120PCS/M
- Hollow design, good heat dissipation
- Can be arbitrarily cropped
- The special design of the plug is convenient for shape docking, and there is no dark area in docking
- The light strip is very soft, convenient for packaging and any shape
- Suitable for indoor and outdoor

- 採用高亮度貼片 2835LED 作為高亮度寬視角光源
- 矽膠材質, 耐候性非常好
- LED數量: 120PCS/M
- 鏤空設計, 散熱性好
- 可以任意裁剪
- 堵頭特殊設計, 方便造型對接, 對接無暗區
- 燈帶非常柔軟, 方便包裝以及任意造型
- 适用于室內室外

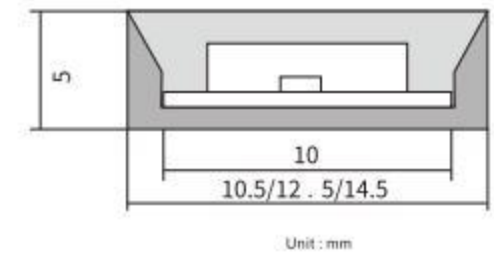
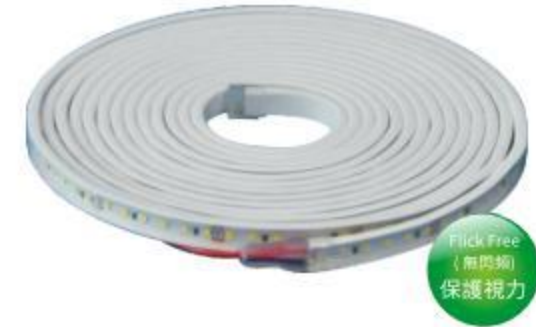

Specification 產品規格 >>

Model 型號	DC Voltage 電壓	Wattage 功率	Lamp Life 光度壽命	Colour Temp 色溫	Lumen Output 輸出流明	Total Lumen 總流明	Color Rendering 顯色度	Waterproof Grade 防水等級	Size 尺寸
	(V)	(W/M)	(Hrs)	(K)	(Lm/M)	(Lm/M)	(CRI)	(IP)	(mm)
SLB-NL1105-HFF	12/24	9.6	50000	3000	100	960	>80	IP67	10.5*5
SLB-NL1305-HFF	12/24	9.6	50000	3000	100	960	>80	IP67	12.5*5
SLB-NL1505-HFF	12/24	9.6	50000	3000	100	960	>80	IP67	14.5*5

- Light efficiency (lm/W), Power (W), Color Rendering Index (CRI), Length can be customized according to customer needs
- Our Standard Power factor (PF) > 0.9 and Total harmonic index THD < 15%, According to customer requirements can produce a lower THD < 10%
- This type of certification is issued by a government-approved laboratory for Safety certification, Fire testing, Restriction of Hazardous Substances (RoHS), Photobiological safety of lamps and lamp systems, (an Exemption Group) and other test certifications to ensure product quality
- 光效 (lm/W)、功率 (W)、顯色指數 (CRI)、長度可根據客戶需求定制
- 此型號標準之功率因素 (PF) > 0.9, 總諧波指數 THD < 15%, 可按客戶需要生產低總諧波指數 < 10%
- 此型號認證由可實驗室發出之安全認證消防測試, 環保物料 (RoHS), 光生物安全為 Exemption Group 及其它測試, 保證客戶使用更安心滿意

T10 Series Neon Light

Series Type: SLB-NL-T10

Features 產品特點 >>

- High brightness patch 2835 LED is adopted as the light source with high brightness and wide Angle of view
- Silicone material, very good weather resistance
- LED Nos: 60PCS/M, side glow
- Hollow design, good heat dissipation
- Three sided light blocking, light emitting flat head, can be cut freely
- The special design of the plug is convenient for shape docking, and there is no dark area in docking
- The light strip is very soft, convenient for packaging and any shape
- Suitable for indoor and outdoor

- 採用高亮度貼片2835LED作為高亮度寬視角光源
- 硅胶材質,耐候性非常好
- LED數量: 60PCS/M, 側面發光
- 鏤空設計, 散熱性好
- 三面擋光, 發光面平頭, 可以任意裁剪
- 堵頭特殊設計, 方便造型對接, 對接無暗區
- 燈帶非常柔軟, 方便包裝以及任意造型
- 适用于室內室外

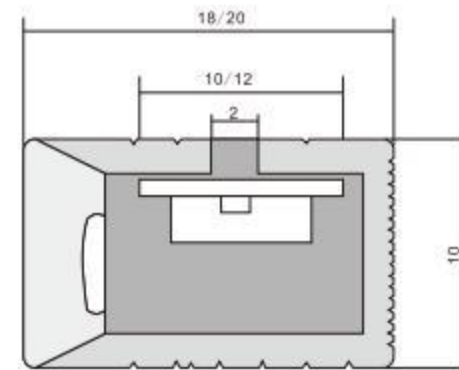
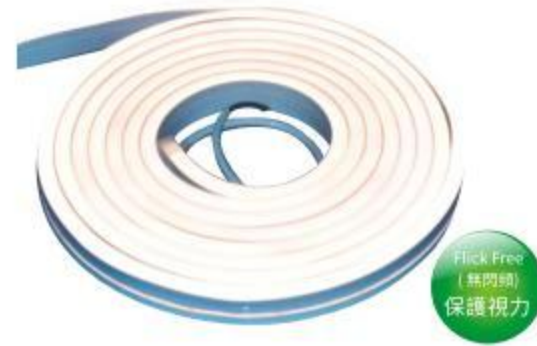

Unit : mm

Specification 產品規格 >>

Model 型號	DC Voltage 電壓	Wattage 功率	Lamp Life 光度壽命	Colour Temp 色溫	Lumen Output 輸出流明	Total Lumen 總流明	Color Rendering 顯色度	Waterproof Grade 防水等級	Size 尺寸
	(V)	(W/M)	(Hrs)	(K)	(Lm/M)	(Lm/M)	(CRI)	(IP)	(mm)
SLB-NL1018-T10FS	12/24	9.6	50000	3000	100	960	>80	IP67	10*18
SLB-NL1020-T10FS	12/24	9.6	50000	3000	100	960	>80	IP67	10*20

- Light efficiency (lm/W), Power (W), Color Rendering Index (CRI), Length can be customized according to customer needs
- Our Standard Power factor (PF) > 0.9 and Total harmonic index THD < 15%, According to customer requirements can produce a lower THD < 10%
- This type of certification is issued by a government-approved laboratory for Safety certification, Fire testing, Restriction of Hazardous Substances (RoHS), Photobiological safety of lamps and lamp systems. (an Exemption Group) and other test certifications to ensure product quality
- 光效 (lm/W)、功率 (W)、顯色指數 (CRI)、長度可根據客戶需求定制
- 此型號標準之功率因素 (PF) > 0.9, 總諧波指數 THD < 15%, 可按客戶需要生產低總諧波指數 < 10%
- 此型號認證由可實驗室發出之安全認證消防測試, 環保物料 (RoHS), 光生物安全為 Exemption Group 及其它測試, 保證客戶使用更安心滿意

T10 Series Neon Light

Series Type: SLB-NL-T10

Features 產品特點 >>

- High brightness patch 2835 LED is adopted as the light source with high brightness and wide Angle of view
- Silicone material, very good weather resistance
- LED Nos: 60PCS/M, side glow
- Hollow design, good heat dissipation
- Three sided light blocking, glowing mushroom head, Can be cut freely
- The special design of the plug is convenient for shape docking, and there is no dark area in docking
- The light strip is very soft, convenient for packaging and any shape
- Suitable for indoor and outdoor

- 採用高亮度貼片2835LED作為高亮度寬視角光源
- 硅胶材質,耐候性非常好
- LED數量: 60PCS/M, 側面發光
- 鏤空設計, 散熱性好
- 三面擋光, 發光面蘑菇頭, 可以任意裁剪
- 堵頭特殊設計, 方便造型對接, 對接無暗區
- 燈帶非常柔軟, 方便包裝以及任意造型
- 适用于室內室外

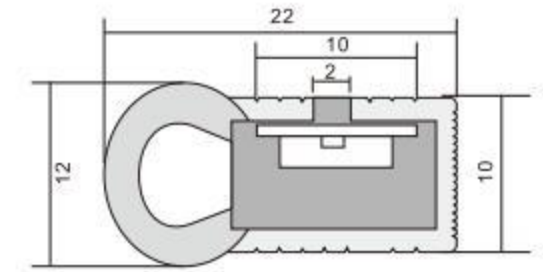

Unit : mm

Specification 產品規格 >>

Model 型號	DC Voltage 電壓	Wattage 功率	Lamp Life 光度壽命	Colour Temp 色溫	Lumen Output 輸出流明	Total Lumen 總流明	Color Rendering 顯色度	Waterproof Grade 防水等級	Size 尺寸
	(V)	(W/M)	(Hrs)	(K)	(Lm/M)	(Lm/M)	(CRI)	(IP)	(mm)
SLB-NL1022-T10MS	12/24	9.6	50000	3000	100	960	>80	IP67	12*22

- Light efficiency (lm/W), Power (W), Color Rendering Index (CRI), Length can be customized according to customer needs
- Our Standard Power factor (PF) > 0.9 and Total harmonic index THD < 15%, According to customer requirements can produce a lower THD < 10%
- This type of certification is issued by a government-approved laboratory for Safety certification, Fire testing, Restriction of Hazardous Substances (RoHS), Photobiological safety of lamps and lamp systems. (an Exemption Group) and other test certifications to ensure product quality
- 光效 (lm/W)、功率 (W)、顯色指數 (CRI)、長度可根據客戶需求定制
- 此型號標準之功率因素 (PF) > 0.9, 總諧波指數 THD < 15%, 可按客戶需要生產低總諧波指數 < 10%
- 此型號認證由可實驗室發出之安全認證消防測試, 環保物料 (RoHS), 光生物安全為 Exemption Group 及其它測試, 保證客戶使用更安心滿意

T10 Series Neon Light

Series Type: SLB-NL-T10

Features 產品特點 >>

- High brightness patch 2835 LED is adopted as the light source with high brightness and wide Angle of view
- Silicone material, very good weather resistance
- LED Nos: 60PCS/M
- Hollow design, good heat dissipation
- Can be arbitrarily cropped
- The special design of the plug is convenient for shape docking, and there is no dark area in docking
- The light strip is very soft, convenient for packaging and any shape
- Suitable for indoor and outdoor

- 採用高亮度貼片2835LED作為高亮度寬視角光源
- 硅胶材質,耐候性非常好
- LED數量: 60PCS/M
- 鏤空設計,散熱性好
- 可以任意裁剪
- 堵頭特殊設計,方便造型對接,對接無暗區
- 燈帶非常柔軟,方便包裝以及任意造型
- 适用于室內室外

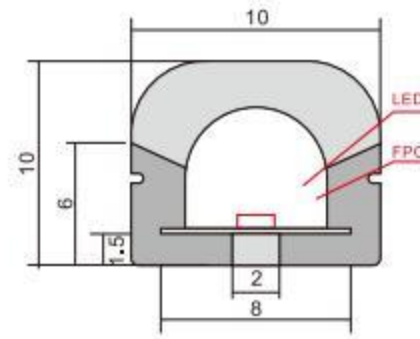
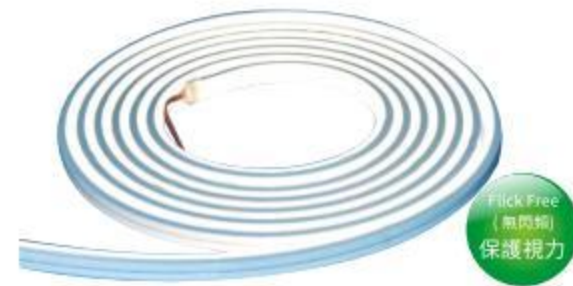

Unit : mm

Specification 產品規格 >>

Model 型號	DC Voltage 電壓	Wattage 功率	Lamp Life 光度壽命	Colour Temp 色溫	Lumen Output 輸出流明	Total Lumen 總流明	Color Rendering 顯色度	Waterproof Grade 防水等級	Size 尺寸
	(V)	(W/M)	(Hrs)	(K)	(Lm/M)	(Lm/M)	(CRI)	(IP)	(mm)
SLB-NL1010-T10FF	12/24	9.6	50000	3000	100	960	>80	IP67	10*10

- Light efficiency (lm/W), Power (W), Color Rendering Index (CRI), Length can be customized according to customer needs
- Our Standard Power factor (PF) > 0.9 and Total harmonic index THD < 15%, According to customer requirements can produce a lower THD < 10%
- This type of certification is issued by a government-approved laboratory for Safety certification, Fire testing, Restriction of Hazardous Substances (RoHS), Photobiological safety of lamps and lamp systems, (an Exemption Group) and other test certifications to ensure product quality

- 光效 (lm/W)、功率 (W)、顯色指數 (CRI)、長度可根據客戶需求定制
- 此型號標準之功率因素 (PF) > 0.9, 總諧波指數 THD < 15%, 可按客戶需要生產低總諧波指數 < 10%
- 此型號認證由可實驗室發出之安全認證消防測試, 環保物料 (RoHS), 光生物安全為 Exemption Group 及其它測試, 保證客戶使用更安心滿意

T12 Series Neon Light

Series Type: SLB-NL-T12

Features 產品特點 >>

- High brightness patch 2835 LED is adopted as the light source with high brightness and wide Angle of view
- Silicone material, very good weather resistance
- LED Nos: 120PCS/M, side glow
- Hollow design, good heat dissipation
- Three sided light blocking, glowing mushroom head, Can be cut freely
- The special design of the plug is convenient for shape docking, and there is no dark area in docking
- The light strip is very soft, convenient for packaging and any shape
- Suitable for indoor and outdoor

- 採用高亮度貼片2835LED作為高亮度寬視角光源
- 硅胶材質,耐候性非常好
- LED數量: 120PCS/M, 側面發光
- 鏤空設計,散熱性好
- 三面擋光,發光面蘑菇頭,可以任意裁剪
- 堵頭特殊設計,方便造型對接,對接無暗區
- 燈帶非常柔軟,方便包裝以及任意造型
- 适用于室內室外

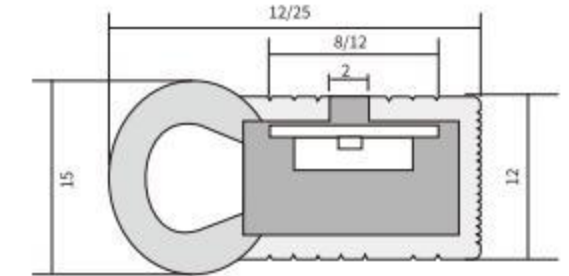

Unit : mm

Specification 產品規格 >>

Model 型號	DC Voltage 電壓	Wattage 功率	Lamp Life 光度壽命	Colour Temp 色溫	Lumen Output 輸出流明	Total Lumen 總流明	Color Rendering 顯色度	Waterproof Grade 防水等級	Size 尺寸
	(V)	(W/M)	(Hrs)	(K)	(Lm/M)	(Lm/M)	(CRI)	(IP)	(mm)
SLB-NL1212-T12MF	12/24	9.6	50000	3000	100	960	>80	IP67	15*12
SLB-NL1525-T12MS	12/24	9.6	50000	3000	100	960	>80	IP67	15*25

- Light efficiency (lm/W), Power (W), Color Rendering Index (CRI), Length can be customized according to customer needs
- Our Standard Power factor (PF) > 0.9 and Total harmonic index THD < 15%, According to customer requirements can produce a lower THD < 10%
- This type of certification is issued by a government-approved laboratory for Safety certification, Fire testing, Restriction of Hazardous Substances (RoHS), Photobiological safety of lamps and lamp systems, (an Exemption Group) and other test certifications to ensure product quality

- 光效 (lm/W)、功率 (W)、顯色指數 (CRI)、長度可根據客戶需求定制
- 此型號標準之功率因素 (PF) > 0.9, 總諧波指數 THD < 15%, 可按客戶需要生產低總諧波指數 < 10%
- 此型號認證由可實驗室發出之安全認證消防測試, 環保物料 (RoHS), 光生物安全為 Exemption Group 及其它測試, 保證客戶使用更安心滿意

T12 Series Neon Light

Series Type: SLB-NL-T12

Features 產品特點 >>

- High brightness patch 2835 LED is adopted as the light source with high brightness and wide Angle of view
- Silicone material, very good weather resistance
- LED Nos: 120PCS/M, side glow
- Hollow design, good heat dissipation
- Three sided light blocking, light emitting flat head, can be cut freely
- The special design of the plug is convenient for shape docking, and there is no dark area in docking
- The light strip is very soft, convenient for packaging and any shape
- Suitable for indoor and outdoor

- 採用高亮度貼片2835LED作為高亮度寬視角光源
- 矽膠材質,耐候性非常好
- LED數量: 120PCS/M, 側面發光
- 鏤空設計, 散熱性好
- 三面擋光, 發光面平頭, 可以任意裁剪
- 堵頭特殊設計, 方便造型對接, 對接無暗區
- 燈帶非常柔軟, 方便包裝以及任意造型
- 适用于室內室外

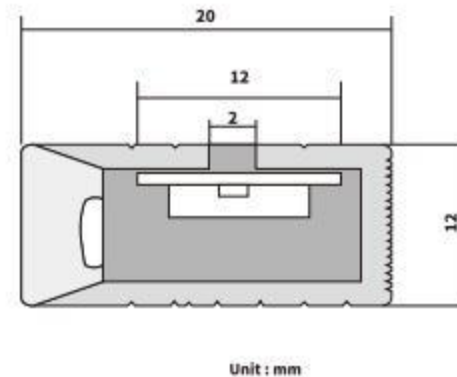

Specification 產品規格 >>

Model 型號	DC Voltage 電壓 (V)	Wattage 功率 (W/M)	Lamp Life 光度壽命 (Hrs)	Colour Temp 色溫 (K)	Lumen Output 輸出流明 (Lm/M)	Total Lumen 總流明 (Lm/M)	Color Rendering 顯色度 (CRI)	Waterproof Grade 防水等級 (IP)	Size 尺寸 (mm)
SLB-NL1220-T12FS	12/24	9.6	50000	3000	100	960	>80	IP67	12*20

- Light efficiency (lm/W), Power (W), Color Rendering Index (CRI), Length can be customized according to customer needs
- Our Standard Power factor (PF) > 0.9 and Total harmonic index THD < 15%, According to customer requirements can produce a lower THD < 10%
- This type of certification is issued by a government-approved laboratory for Safety certification, Fire testing, Restriction of Hazardous Substances (RoHS), Photobiological safety of lamps and lamp systems. (an Exemption Group) and other test certifications to ensure product quality
- 光效 (lm/W)、功率 (W)、顯色指數 (CRI)、長度可根據客戶需求定制
- 此型號標準之功率因素 (PF) > 0.9, 總諧波指數 THD < 15%, 可按客戶需要生產低總諧波指數 < 10%
- 此型號認證由可實驗室發出之安全認證消防測試, 環保物料 (RoHS), 光生物安全為 Exemption Group 及其它測試, 保證客戶使用更安心滿意

T12 Series Neon Light

Series Type: SLB-NL-T12

Features 產品特點 >>

- High brightness patch 2835 LED is adopted as the light source with high brightness and wide Angle of view
- Silicone material, very good weather resistance
- LED Nos: 120PCS/M
- Hollow design, good heat dissipation
- Can be arbitrarily cropped
- The special design of the plug is convenient for shape docking, and there is no dark area in docking
- The light strip is very soft, convenient for packaging and any shape
- Suitable for indoor and outdoor

- 採用高亮度貼片2835LED作為高亮度寬視角光源
- 矽膠材質,耐候性非常好
- LED數量: 120PCS/M
- 鏤空設計, 散熱性好
- 可以任意裁剪
- 堵頭特殊設計, 方便造型對接, 對接無暗區
- 燈帶非常柔軟, 方便包裝以及任意造型
- 适用于室內室外

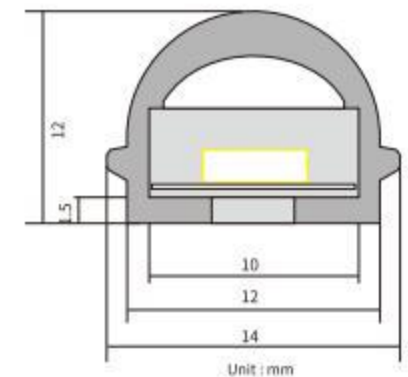

Specification 產品規格 >>

Model 型號	DC Voltage 電壓 (V)	Wattage 功率 (W/M)	Lamp Life 光度壽命 (Hrs)	Colour Temp 色溫 (K)	Lumen Output 輸出流明 (Lm/M)	Total Lumen 總流明 (Lm/M)	Color Rendering 顯色度 (CRI)	Waterproof Grade 防水等級 (IP)	Size 尺寸 (mm)
SLB-NL1412-T12MF	12/24	9.6	50000	3000	100	960	>80	IP67	14*12

- Light efficiency (lm/W), Power (W), Color Rendering Index (CRI), Length can be customized according to customer needs
- Our Standard Power factor (PF) > 0.9 and Total harmonic index THD < 15%, According to customer requirements can produce a lower THD < 10%
- This type of certification is issued by a government-approved laboratory for Safety certification, Fire testing, Restriction of Hazardous Substances (RoHS), Photobiological safety of lamps and lamp systems. (an Exemption Group) and other test certifications to ensure product quality
- 光效 (lm/W)、功率 (W)、顯色指數 (CRI)、長度可根據客戶需求定制
- 此型號標準之功率因素 (PF) > 0.9, 總諧波指數 THD < 15%, 可按客戶需要生產低總諧波指數 < 10%
- 此型號認證由可實驗室發出之安全認證消防測試, 環保物料 (RoHS), 光生物安全為 Exemption Group 及其它測試, 保證客戶使用更安心滿意

T15 Series Neon Light

Series Type: SLB-NL-T15

Features 產品特點 >>

- High brightness patch 2835 LED is adopted as the light source with high brightness and wide Angle of view
- Silicone material, very good weather resistance
- LED Nos: 120PCS/M
- Hollow design, good heat dissipation
- Can be arbitrarily cropped
- The special design of the plug is convenient for shape docking, and there is no dark area in docking
- The light strip is very soft, convenient for packaging and any shape
- Suitable for indoor and outdoor

- 採用高亮度貼片 2835LED 作為高亮度寬視角光源
- 硅胶材質, 耐候性非常好
- LED數量: 120PCS/M
- 鏤空設計, 散熱性好
- 可以任意裁剪
- 堵頭特殊設計, 方便造型對接, 對接無暗區
- 燈帶非常柔軟, 方便包裝以及任意造型
- 适用于室內室外

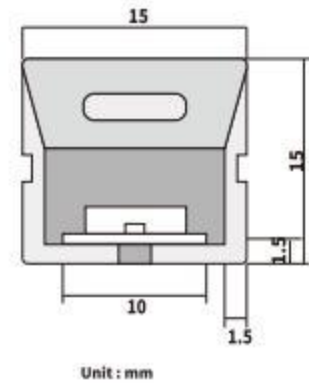

Specification 產品規格 >>

Model 型號	DC Voltage 電壓	Wattage 功率	Lamp Life 光度壽命	Colour Temp 色溫	Lumen Output 輸出流明	Total Lumen 總流明	Color Rendering 顯色度	Waterproof Grade 防水等級	Size 尺寸
	(V)	(W/M)	(Hrs)	(K)	(Lm/M)	(Lm/M)	(CRI)	(IP)	(mm)
SLB-NL1515-T15FF	12/24	9.6	50000	3000	100	960	>80	IP67	15*15

- Light efficiency (lm/W), Power (W), Color Rendering Index (CRI), Length Can be customized according to customer needs
- Our Standard Power factor (PF) > 0.9 and Total harmonic index THD < 15%, According to customer requirements can produce a lower THD < 10%
- This type of certification is issued by a government-approved laboratory for Safety certification, Fire testing, Restriction of Hazardous Substances (RoHS), Photobiological safety of lamps and lamp systems. (an Exemption Group) and other test certifications to ensure product quality

- 光效 (lm/W)、功率 (W)、顯色指數 (CRI), 長度可根據客戶需求定制
- 此型號標準之功率因素 (PF) > 0.9, 總諧波指數 THD < 15%, 可按客戶需要生產低總諧波指數 < 10%
- 此型號認證由可實驗室發出之安全認證消防測試, 環保物料 (RoHS), 光生物安全為 Exemption Group 及其它測試, 保證客戶使用更安心滿意

T15 Series Neon Light

Series Type: SLB-NL-T15

Features 產品特點 >>

- High brightness patch 2835 LED is adopted as the light source with high brightness and wide Angle of view
- Silicone material, very good weather resistance
- LED Nos: 120PCS/M
- Hollow design, good heat dissipation
- Can be arbitrarily cropped
- The special design of the plug is convenient for shape docking, and there is no dark area in docking
- The light strip is very soft, convenient for packaging and any shape
- Suitable for indoor and outdoor

- 採用高亮度貼片 2835LED 作為高亮度寬視角光源
- 硅胶材質, 耐候性非常好
- LED數量: 120PCS/M
- 鏤空設計, 散熱性好
- 可以任意裁剪
- 堵頭特殊設計, 方便造型對接, 對接無暗區
- 燈帶非常柔軟, 方便包裝以及任意造型
- 适用于室內室外

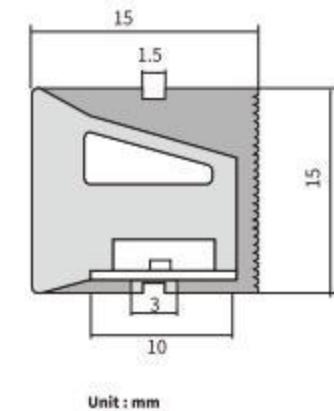

Specification 產品規格 >>

Model 型號	DC Voltage 電壓	Wattage 功率	Lamp Life 光度壽命	Colour Temp 色溫	Lumen Output 輸出流明	Total Lumen 總流明	Color Rendering 顯色度	Waterproof Grade 防水等級	Size 尺寸
	(V)	(W/M)	(Hrs)	(K)	(Lm/M)	(Lm/M)	(CRI)	(IP)	(mm)
SLB-NL1715-T15MF	12/24	9.6	50000	3000	100	960	>80	IP67	16.8*14.5

- Light efficiency (lm/W), Power (W), Color Rendering Index (CRI), Length Can be customized according to customer needs
- Our Standard Power factor (PF) > 0.9 and Total harmonic index THD < 15%, According to customer requirements can produce a lower THD < 10%
- This type of certification is issued by a government-approved laboratory for Safety certification, Fire testing, Restriction of Hazardous Substances (RoHS), Photobiological safety of lamps and lamp systems. (an Exemption Group) and other test certifications to ensure product quality

- 光效 (lm/W)、功率 (W)、顯色指數 (CRI), 長度可根據客戶需求定制
- 此型號標準之功率因素 (PF) > 0.9, 總諧波指數 THD < 15%, 可按客戶需要生產低總諧波指數 < 10%
- 此型號認證由可實驗室發出之安全認證消防測試, 環保物料 (RoHS), 光生物安全為 Exemption Group 及其它測試, 保證客戶使用更安心滿意

T15 Series Neon Light

Series Type: SLB-NL-T15

Features 產品特點 >>

- High brightness patch 2835 LED is adopted as the light source with high brightness and wide Angle of view
- Silicone material, very good weather resistance
- LED Nos: 120PCS/M
- Hollow design, good heat dissipation
- Can be arbitrarily cropped
- The special design of the plug is convenient for shape docking, and there is no dark area in docking
- The light strip is very soft, convenient for packaging and any shape
- Suitable for indoor and outdoor

- 採用高亮度贴片 2835LED 作為高亮度寬視角光源
- 硅胶材質, 耐候性非常好
- LED數量: 120PCS/M
- 鑲空設計, 散熱性好
- 可以任意裁剪
- 堵頭特殊設計, 方便造型對接, 對接無暗區
- 燈帶非常柔軟, 方便包裝以及任意造型
- 适用于室內室外

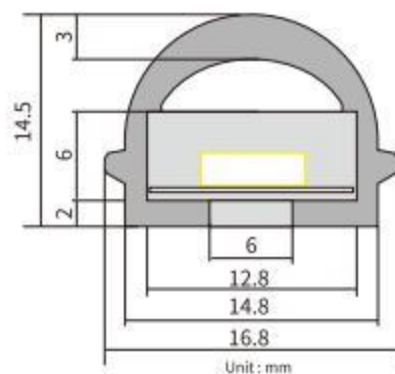

Specification 產品規格 >>

Model 型號	DC Voltage 電壓 (V)	Wattage 功率 (W/M)	Lamp Life 光度壽命 (Hrs)	Colour Temp 色溫 (K)	Lumen Output 輸出流明 (Lm/M)	Total Lumen 總流明 (Lm/M)	Color Rendering 顯色度 (CRI)	Waterproof Grade 防水等級 (IP)	Size 尺寸 (cm)
SLB-NL1515-T15FS	12/24	9.6	50000	3000	100	960	>80	IP67	15*15

- Light efficiency (lm/W), Power (W), Color Rendering Index (CRI), Length can be customized according to customer needs
- Our Standard Power factor (PF) > 0.9 and Total harmonic index THD < 15%, According to customer requirements can produce a lower THD < 10%
- This type of certification is issued by a government-approved laboratory for Safety certification, Fire testing, Restriction of Hazardous Substances (RoHS), Photobiological safety of lamps and lamp systems, (an Exemption Group) and other test certifications to ensure product quality

- 光效 (lm/W)、功率 (W)、顯色指數 (CRI), 長度可根據客戶需求定制
- 此型號標準之功率因素 (PF) > 0.9, 總諧波指數 THD < 15%, 可按客戶需要生產低總諧波指數 < 10%
- 此型號認證由可實驗室發出之安全認證消防測試, 環保物料 (RoHS), 光生物安全為 Exemption Group 及其它測試, 保證客戶使用更安心滿意

LED Flex Neon Light

Series Type: SLB-NL-T10

Features 產品特點 >>

- Top grade silicon material. Good weather resistance
- Top view / bend up & down
- LED Nos: 120 PCS/M
- Hollow design. Good heat dissipation
- Exceptional soft and bright lighting output
- Flexible to bend for easy installation
- Rating IP65. Suitable for indoor and outdoor installation
- With meanwell dimming driver
- Suitable for embedded and surface mounting

- 頂級矽材料, 具有良好的耐候性
- 俯視圖/上下彎曲
- LED數量: 120個/M
- 中空設計, 散熱良好
- 卓越的柔和明亮的照明輸出
- 彎曲靈活, 便於安裝
- 防護等級 IP65, 適用於室內外安裝
- 帶 meanwell 調光驅動器
- 適用於嵌入式和表面安裝

Optional installation accessories:

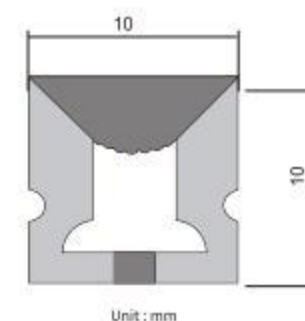

Specification 產品規格 >>

Model 型號	DC Voltage 電壓 (V)	Wattage 功率 (W/M)	Lamp Life 光度壽命 (Hrs)	Colour Temp 色溫 (K)	Beam Angle 光束角度 (°)	Total Lumen 總流明 (Lm/M)	Color Rendering 顯色度 (CRI)	Waterproof Grade 防水等級 (IP)	Size 尺寸 (mm)
SLB-NL1010-T10	24	12.5	up to 30000	4000	120	1000	≥80	IP65	10*10

- Light efficiency (lm/W), Power (W), Color Rendering Index (CRI), Length can be customized according to customer needs
- Our Standard Power factor (PF) > 0.9 and Total harmonic index THD < 15%, According to customer requirements can produce a lower THD < 10%
- This type of certification is issued by a government-approved laboratory for Safety certification, Fire testing, Restriction of Hazardous Substances (RoHS), Photobiological safety of lamps and lamp systems, (an Exemption Group) and other test certifications to ensure product quality

- 光效 (lm/W)、功率 (W)、顯色指數 (CRI), 長度可根據客戶需求定制
- 此型號標準之功率因素 (PF) > 0.9, 總諧波指數 THD < 15%, 可按客戶需要生產低總諧波指數 < 10%
- 此型號認證由可實驗室發出之安全認證消防測試, 環保物料 (RoHS), 光生物安全為 Exemption Group 及其它測試, 保證客戶使用更安心滿意



CABINET LIGHT

櫃燈系列



LED Cabinet Light Small Round

Series Type: KBL-C



Flick Free
(無閃爍)
保護視力

Features 產品特點 >>

- 12mm thickness design, Invisible LED Chip
- Uniform light emission, The beam angle is 180°
- Low Power consumption < 2W
- Other options:(1)1-10V input , Dimmable brightness output
(2)Manual or Remote control function
- Application: Kitchen cabinet , Wine cabinet & Wardrobe, Bathroom cabinet ,Closet, Show cabinet ,etc
- 12毫米厚度設計, 隱形LED晶片
- 發光均勻, 光束角度180°
- 低功耗< 2W
- 其他選項: (1) 1- 10v輸入, 可調亮度輸出
(2) 手動或遙控功能
- 適用範圍: 廚櫃、酒櫃、衣櫃、浴室櫃、衣櫃、陳列櫃等

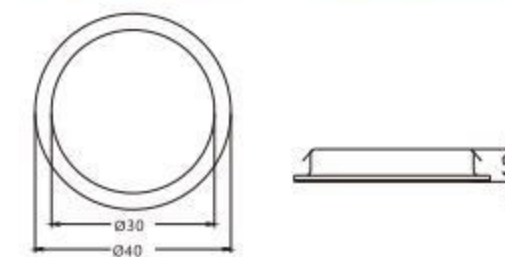

Unit : mm

Specification 產品規格 >>

Model 型號	DC Voltage 電壓	Wattage 功率	Standard Size 標準尺寸	Lamp Life 光度壽命	Colour Temp 色溫	Lumen Output 輸出流明	Color Rendering 顯色度	Hole Size 孔尺寸	Pcs Box 每箱數量
	(V)	(W)	(mm)	(Hrs)	(K)	(Lm/W)	(CRI)	(mm)	(Pcs)
KBL-C0201-S88E	12/24	1	40*12	50000	3000/4000/6500	80	>93	Ø35	25

- Light efficiency (lm/W), Power (W), Color Rendering Index (CRI), Can be customized according to customer needs
- Our Standard Power factor (PF) > 0.9 and Total harmonic index THD < 15%, According to customer requirements can produce a lower THD < 10%
- This type of certification is issued by a government-approved laboratory for Safety certification, Fire testing, Restriction of Hazardous Substances (RoHS), Photobiological safety of lamps and lamp systems, (an Exemption Group) and other test certifications to ensure product quality
- 光效 (lm/W)、功率 (W)、顯色指數 (CRI), 可根據客戶需求定制
- 此型號標準之功率因素 (PF) > 0.9, 總諧波指數 THD < 15%, 可按客戶需要生產低總諧波指數 < 10%
- 此型號認證由可實驗室發出之安全認證消防測試, 環保物料 (RoHS), 光生物安全為 Exemption Group 及其它測試, 保證客戶使用更安心滿意

LED Cabinet Light Small Square

Series Type: KBL-S

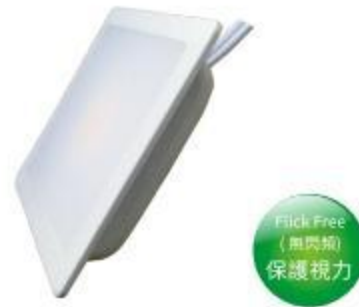

Features 產品特點 >>

- 12mm thickness design ,Invisible LED Chip
- Uniform light emission, The beam angle is 180°
- Low Power consumption < 2W
- Other options:(1)1-10V input , Dimmable brightness output
(2)Manual or Remote control function
- Application: Kitchen cabinet, Wine cabinet & Wardrobe, Bathroom cabinet ,Closet, Show cabinet ,etc
- 12毫米厚度設計, 隱形LED晶片
- 發光均勻, 光束角度180°
- 低功耗< 2W
- 其他選項: (1) 1- 10v輸入, 可調亮度輸出
(2) 手動或遙控功能
- 適用範圍: 廚櫃、酒櫃、衣櫃、浴室櫃、衣櫃、陳列櫃等

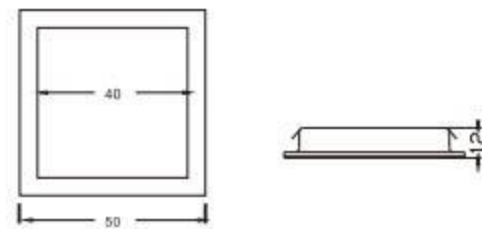

Unit : mm

Specification 產品規格 >>

Model 型號	DC Voltage 電壓	Wattage 功率	Standard Size 標準尺寸	Lamp Life 光度壽命	Colour Temp 色溫	Lumen Output 輸出流明	Color Rendering 顯色度	Hole Size 孔尺寸	Pcs Box 每箱數量
	(V)	(W)	(mm)	(Hrs)	(K)	(Lm/W)	(CRI)	(mm)	(Pcs)
KBL-S0201-S88E	12/24	1	50*12	50000	3000/4000/6500	80	>93	Ø45	25

- Light efficiency (lm/W),Power (W),Color Rendering Index (CRI). Can be customized according to customer needs
- Our Standard Power factor (PF) > 0.9 and Total harmonic index THD < 15%. According to customer requirements can produce a lower THD< 10%
- This type of certification is issued by a government-approved laboratory for Safety certification, Fire testing, Restriction of Hazardous Substances(RoHS), Photobiological safety of lamps and lamp systems.(an Exemption Group) and other test certifications to ensure product quality

- 光效 (lm/W)、功率 (W)、顯色指數 (CRI), 可根據客戶需求定制
- 此型號標準之功率因素 (PF)>0.9, 總諧波指數THD<15%, 可按客戶需要生產低總諧波指數< 10%
- 此型號認證由可實驗室發出之安全認證消防測試, 環保物料 (RoHS), 光生物安全為Exemption Group及其它測試, 保證客戶使用更安心滿意

LED Cabinet Light Big Round

Series Type: KBL-C



Features 產品特點 >>

- 12mm thickness design ,Invisible LED Chip
- Uniform light emission, The beam angle is 180°
- Low Power consumption < 2W
- Other options:(1)1-10V input , Dimmable brightness output
(2)Manual or Remote control function
- Application: Kitchen cabinet, Wine cabinet & Wardrobe, Bathroom cabinet ,Closet, Show cabinet ,etc
- 12毫米厚度設計,隱形LED晶片
- 發光均勻, 光束角度180°
- 低功耗< 2W
- 其他選項: (1) 1- 10v輸入, 可調亮度輸出
(2) 手動或遙控功能
- 適用範圍: 廚櫃、酒櫃、衣櫃、浴室櫃、衣櫃、陳列櫃等

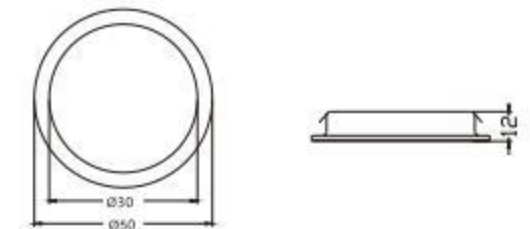

Unit : mm

Specification 產品規格 >>

Model 型號	DC Voltage 電壓	Wattage 功率	Standard Size 標準尺寸	Lamp Life 光度壽命	Colour Temp 色溫	Lumen Output 輸出流明	Color Rendering 顯色度	Hole Size 孔尺寸	Pcs Box 每箱數量
	(V)	(W)	(mm)	(Hrs)	(K)	(Lm/W)	(CRI)	(mm)	(Pcs)
KBL-C0302	12/24	2	50*12	50000	3000/4000/6500	100	>80	Ø45	25

- Light efficiency (lm/W),Power (W),Color Rendering Index (CRI). Can be customized according to customer needs
- Our Standard Power factor (PF) > 0.9 and Total harmonic index THD < 15%. According to customer requirements can produce a lower THD< 10%
- This type of certification is issued by a government-approved laboratory for Safety certification, Fire testing, Restriction of Hazardous Substances(RoHS), Photobiological safety of lamps and lamp systems.(an Exemption Group) and other test certifications to ensure product quality

- 光效 (lm/W)、功率 (W)、顯色指數 (CRI), 可根據客戶需求定制
- 此型號標準之功率因素 (PF)>0.9, 總諧波指數THD<15%, 可按客戶需要生產低總諧波指數< 10%
- 此型號認證由可實驗室發出之安全認證消防測試, 環保物料 (RoHS), 光生物安全為Exemption Group及其它測試, 保證客戶使用更安心滿意

Recessed LED Cabinet Light Surface Round

Series Type: KBL-IB



Features 產品特點 >>

- 12mm thickness design ,Invisible LED Chip
- Uniform light emission, The beam angle is 180°
- Low Power consumption < 2W
- Other options:(1)1-10V input , Dimmable brightness output
(2)Manual or Remote control function
- Application: Kitchen cabinet, Wine cabinet & Wardrobe, Bathroom cabinet ,Closet, Show cabinet ,etc
- 12毫米厚度設計,隱形LED晶片
- 發光均勻,光束角度180°
- 低功耗< 2W
- 其他選項: (1) 1- 10v輸入, 可調亮度輸出
(2) 手動或遙控功能
- 適用範圍: 廚櫃、酒櫃、衣櫃、浴室櫃、衣櫃、陳列櫃等

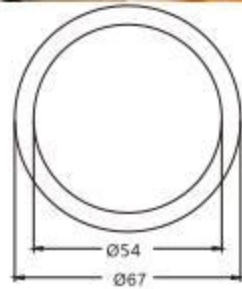

Unit : mm

Specification 產品規格 >>

Model 型號	DC Voltage 電壓	Wattage 功率	Standard Size 標準尺寸	Lamp Life 光度壽命	Colour Temp 色溫	Lumen Output 輸出流明	Color Rendering 顯色度	Hole Size 孔尺寸	Pcs Box 每箱數量
	(V)	(W)	(mm)	(Hrs)	(K)	(Lm/W)	(CRI)	(mm)	(Pcs)
KBL-IB0302-S88E	12/24	1	67*12	50000	3000/4000/6500	80	>93	Ø67	25

- Light efficiency (lm/W),Power (W),Color Rendering Index (CRI), Can be customized according to customer needs
- Our Standard Power factor (PF) > 0.9 and Total harmonic index THD < 15%, According to customer requirements can produce a lower THD< 10%
- This type of certification is issued by a government-approved laboratory for Safety certification, Fire testing, Restriction of Hazardous Substances(RoHS), Photobiological safety of lamps and lamp systems,(an Exemption Group) and other test certifications to ensure product quality

- 光效 (lm/W)、功率 (W)、顯色指數 (CRI), 可根據客戶需求定制
- 此型號標準之功率因素 (PF)>0.9, 總諧波指數THD<15%, 可按客戶需要生產低總諧波指數< 10%
- 此型號認證由可實驗室發出之安全認證消防測試, 環保物料 (RoHS), 光生物安全為Exemption Group及其它測試, 保證客戶使用更安心滿意

Recessed LED Cabinet Light

Series Type: KBL-0302



Features 產品特點 >>

- 12mm thickness design ,Invisible LED Chip
- Uniform light emission, The beam angle is 180°
- Low Power consumption < 2W,Shell color: white/black/silver
- Other options:(1)1-10V input , Dimmable brightness output
(2)Manual or Remote control function
- Application: Kitchen cabinet, Wine cabinet & Wardrobe, Bathroom cabinet ,Closet, Show cabinet ,etc
- 12毫米厚度設計,隱形LED晶片
- 發光均勻,光束角度180°
- 低功耗< 2W,外殼顏色: 白/黑/銀
- 其他選項: (1) 1- 10v輸入, 可調亮度輸出
(2) 手動或遙控功能
- 適用範圍: 廚櫃、酒櫃、衣櫃、浴室櫃、衣櫃、陳列櫃等

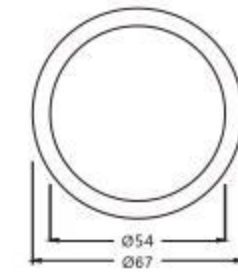

Unit : mm

Specification 產品規格 >>

Model 型號	DC Voltage 電壓	Wattage 功率	Standard Size 標準尺寸	Lamp Life 光度壽命	Colour Temp 色溫	Lumen Output 輸出流明	Color Rendering 顯色度	Hole Size 孔尺寸	Pcs Box 每箱數量
	(V)	(W)	(mm)	(Hrs)	(K)	(Lm/W)	(CRI)	(mm)	(Pcs)
KBL-0302	12/24	2	67*12	50000	3000/4000/6500	100	>80	Ø58	25

- Light efficiency (lm/W),Power (W),Color Rendering Index (CRI), Can be customized according to customer needs
- Our Standard Power factor (PF) > 0.9 and Total harmonic index THD < 15%, According to customer requirements can produce a lower THD< 10%
- This type of certification is issued by a government-approved laboratory for Safety certification, Fire testing, Restriction of Hazardous Substances(RoHS), Photobiological safety of lamps and lamp systems,(an Exemption Group) and other test certifications to ensure product quality

- 光效 (lm/W)、功率 (W)、顯色指數 (CRI), 可根據客戶需求定制
- 此型號標準之功率因素 (PF)>0.9, 總諧波指數THD<15%, 可按客戶需要生產低總諧波指數< 10%
- 此型號認證由可實驗室發出之安全認證消防測試, 環保物料 (RoHS), 光生物安全為Exemption Group及其它測試, 保證客戶使用更安心滿意

LED Cabinet Light

Series Type: KBL-PIR

Features 產品特點 >>

- 40mm thickness design ,Invisible LED Chip
- Uniform light emission,The beam angle is 180°
- Light weight only 122g
- PIR : 2-3meter detect area,Hold time 30 sec if nobody
- Application: Kitchen cabinet, Wine cabinet & Wardrobe, Show cabinet ,etc
- 40毫米厚度設計,隱形LED晶片
- 發光均勻,光束角度180°
- 重量輕,僅122g
- PIR:2-3米探測區,無人時保持30秒
- 適用範圍: 廚櫃、酒櫃及衣櫃、展示櫃等

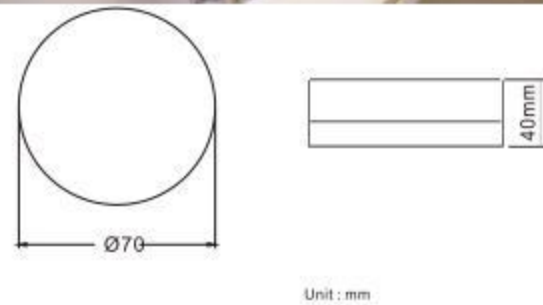

Specification 產品規格 >>

Model 型號	DC Voltage 電壓	Wattage 功率	Standard Size 標準尺寸	Lamp Life 光度壽命	Colour Temp 色溫	Lumen Output 輸出流明	Color Rendering 顯色度	Operation temperature 工作溫度	Pcs Box 每箱數量
	(V)	(W)	(mm)	(Hrs)	(K)	(Lm/W)	(CRI)	(°C)	(Pcs)
KBL-0401-PIR	5	1	70*40	50000	3000/4000/6500	80	>90	-10~40	25

- Light efficiency (lm/W),Power (W),Color Rendering Index (CRI), Can be customized according to customer needs
- Our Standard Power factor (PF) > 0.9 and Total harmonic index THD < 15%, According to customer requirements can produce a lower THD< 10%
- This type of certification is issued by a government-approved laboratory for Safety certification, Fire testing, Restriction of Hazardous Substances(RoHS), Photobiological safety of lamps and lamp systems.(an Exemption Group) and other test certifications to ensure product quality

- 光效 (lm/W)、功率 (W)、顯色指數 (CRI), 可根據客戶需求定制
- 此型號標準之功率因素 (PF)>0.9, 總諧波指數THD<15%, 可按客戶需要生產低總諧波指數< 10%
- 此型號認證由可實驗室發出之安全認證消防測試, 環保物料 (RoHS), 光生物安全為Exemption Group及其它測試, 保證客戶使用更安心滿意

Recessed LED Cabinet Light

Series Type: KBL-0303

Features 產品特點 >>

- 13mm thickness design, invisible LED Chip
- Uniform light emission, The beam angle is 180°
- Shell color white/black/silver
- Application: Kitchen cabinet, Wine cabinet & Wardrobe, Bathroom cabinet ,Closet, Show cabinet ,etc
- 13毫米厚度設計,隱形LED晶片
- 發光均勻,光束角度180°
- 外殼顏色白色/黑色/銀色
- 適用範圍: 廚櫃、酒櫃、衣櫃、浴室櫃、衣櫃、陳列櫃等

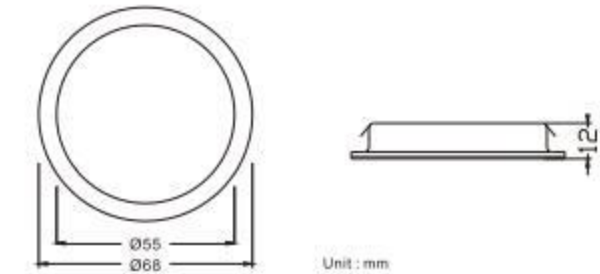

Specification 產品規格 >>

Model 型號	DC Voltage 電壓	Wattage 功率	Standard Size 標準尺寸	Lamp Life 光度壽命	Colour Temp 色溫	Lumen Output 輸出流明	Color Rendering 顯色度	Hole Size 孔尺寸	Pcs Box 每箱數量
	(V)	(W)	(mm)	(Hrs)	(K)	(Lm/W)	(CRI)	(mm)	(Pcs)
KBL-0303	12	3	Ø68*13	30000	3000/4000/6500	90	>80	Ø58	25

- Light efficiency (lm/W),Power (W),Color Rendering Index (CRI), Can be customized according to customer needs
- Our Standard Power factor (PF) > 0.9 and Total harmonic index THD < 15%, According to customer requirements can produce a lower THD< 10%
- This type of certification is issued by a government-approved laboratory for Safety certification, Fire testing, Restriction of Hazardous Substances(RoHS), Photobiological safety of lamps and lamp systems.(an Exemption Group) and other test certifications to ensure product quality

- 光效 (lm/W)、功率 (W)、顯色指數 (CRI), 可根據客戶需求定制
- 此型號標準之功率因素 (PF)>0.9, 總諧波指數THD<15%, 可按客戶需要生產低總諧波指數< 10%
- 此型號認證由可實驗室發出之安全認證消防測試, 環保物料 (RoHS), 光生物安全為Exemption Group及其它測試, 保證客戶使用更安心滿意

1-6 without the line

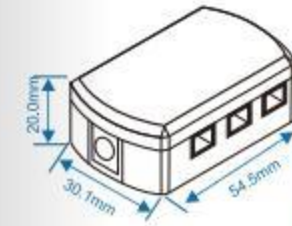

Model	CJB-1IN60-2P
Material	PC
Control	No Switch
1 Input (V)	DC12V/DC24V
6 Output (V)	DC12V/DC24V

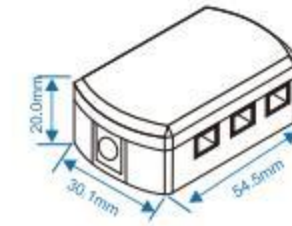

Model	CJB-1IN1SW50-2P
Material	PC
Control	1 Switch
1 Input (V)	DC12V/DC24V
5 Output (V)	DC12V/DC24V

1-10 with the line

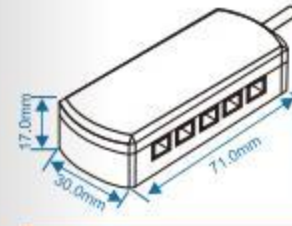

Model	CJB-1IN10-2P
Material	PC
Standard Size (mm)	71*30X17
1 Input (V)	DC12V/DC24V
10 Output (V)	DC12V/DC24V

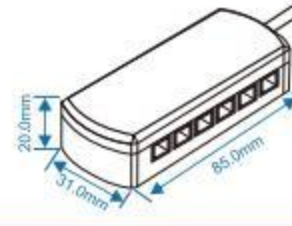

Model	CJB-1W10-2P-L
Material	PC
Standard Size (mm)	85*31*20
1 Input (V)	DC12V/DC24V
12 Output (V)	DC12V/DC24V

1-6 with the line

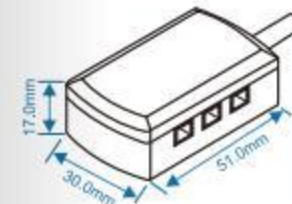

Model	CJB-1IN60-2P-SL
Material	PC
Standard Size (mm)	51*30X17
1 Input (V)	DC12V/DC24V
6 Output (V)	DC12V/DC24V

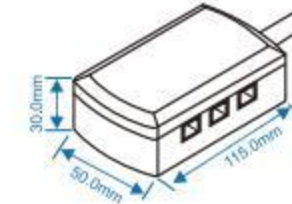

Model	CJB-1N60-2P-DC
Material	PC
Standard Size (mm)	115*50*30
1 Input (V)	DC12V/DC24V
6 Output (V)	DC12V/DC24V

1-4 with the line

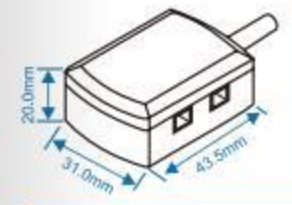

Model	CJB-CJB-1N40-2P-L
Material	PC
Standard Size (mm)	43.5*31*20
1 Input (V)	DC12V/DC24V
6 Output (V)	DC12V/DC24V

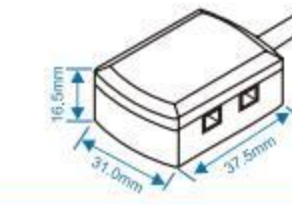

Model	CJB-1INN40-2P-SL
Material	PC
Standard Size (mm)	37.5*31*16.5
1 Input (V)	DC12V/DC24V
4 Output (V)	DC12V/DC24V

Junction Box

接線盒

Installation Buckle & Clamp

安裝扣和卡箍

