



# CATALOG

## 2. Strip & Cabinet

EASTLIKE LED Co., Ltd

LED Lighting Series

Green

Low Carbon

Energy Saving





# 公司簡介 Company Profile



製造和營銷綠色低碳節能照明產品  
Manufacturing And Marketing Green Low Carbon  
And Energy Saving Lighting Products

LED Lighting®

LED Lighting®  
**EAST**

## EASTLIKE LED COMPANY 東 欖 照 明 公 司

EASTLIKE LED Co., Ltd • emerges as a lighting designer, manufacturer and supplier established in Hong Kong and Mainland China .

The company devotes herself in the development, manufacturing and marketing of green, low-carbon and energy-saving lighting products. we are proud to provide a wide range of LED products

東欖LED照明公司□您的照明設計師。

我們作為製造商和供應服務於香港和中國大陸。公司致力於開發，製造和行銷綠色，低碳和節能照明產品。

我們竭誠為您服務，為您提供種類繁多的LED產品。



# 目录

# Content



P.01  
P1013硬灯条橱柜灯



P.02  
P1013迷你款硬灯条



P.03  
迷你小射灯



P.04  
超薄人体感应灯



P.05  
超薄人体感应灯



P.06  
10\*10嵌入式柔性硅胶灯带



P.07  
12\*12嵌入式柔性硅胶灯带



P.08  
A1013铝灯条



P.09  
A3030铝灯条



P.10  
A1418铝灯条



P.11  
A2008铝灯条



P.12  
C2310L铝灯条



P.13  
C2408L铝灯条



P.14  
C1712L铝灯条

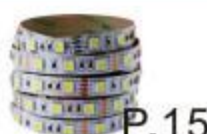

P.15  
S5050贴片单色灯带



P.16  
2835贴片防水胶灯带



P.17  
2835贴片RGB防水灯带



P.18  
2835贴片双色防水灯带



P.19  
T5防水霓虹灯带



P.20  
T10防水霓虹灯带



P.21  
T15防水霓虹灯带

# P1013 Hard Light Bar Cabinet Light

Series Type: EKBCB12



## Features 產品特點

- ★ Small size: 10 mm (width) \*13 mm (height)
- ★ Minimum cutting length < 3mm
- ★ Design with SPM - cut off single LED in case of failure
- ★ Thermal conductive plastic with the best heat dissipation
- ★ Series installation for seamless lighting output
- ★ Uniform illumination, no LED light spot
- ★ Application: cabinet, bathroom cabinet, wardrobe, display cabinet, retail store, etc

- ★ 尺寸:10.00毫米(寬)\*13.00毫米(高)
- ★ 最小切割長度<3mm
- ★ 使用SPM設計-故障時切斷單個LED
- ★ 採用最佳散熱的導熱塑膠
- ★ 串聯安裝以實現無縫照明輸出
- ★ 發光均勻,無LED光點
- ★ 應用:櫥櫃、浴室櫃、衣櫃、展示櫃、零售店等

## Specification 產品規格

Model 型號	Voltage 電壓	Power 功率	Lumen Output 輸出流明	Color Rendering 顯色度	Colour Temp 色溫	Life Time 壽命	Beam Angle 光束角	Working temperature 工作溫度	Size 尺寸
	(V)	(W)	(lm/W)	(CRI)	(K)	(H)	(°)	(°C)	(mm)
ECBL-P1013-109C27	Dc24	10	100	>80	2700	30000	270	-20~45	1200*10*13
ECBL-P1013-109C3	DC24	10	100	>80	3000	30000	270	-20~45	1200*10*13

Light efficiency (lm/W), Power (W), Color Rendering Index (CRI), Can be customized according to customer needs.

Our Standard Power factor (PF) > 0.9 and Total harmonic index THD < 15%, According to customer requirements can produce a lower THD < 10%.

This type of certification is issued by a government-approved laboratory for Safety certification, Fire testing, Restriction of Hazardous Substances (RoHS), Photobiological safety of lamps and lamp systems. (an Exemption Group) and other test certifications to ensure product quality

光效 (lm/W)、功率 (W)、顯色指數 (CRI), 可根據客戶需求定制。

此型號標準之功率因素 (PF) > 0.9, 總諧波指數 THD < 15%, 可按客戶需要生產低總諧波指數 < 10%。

此型號認證由可實驗室發出之安全認證消防測試, 環保物料 (RoHS), 光生物安全為 Exemption Group 及其它測試, 保證客戶使用更安心滿意。

# P1013 Mini Cabinet Lamp

Series Type: EKBCB03

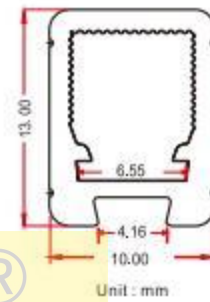

## Features 產品特點

- ★ Track type magnetic absorber can drive multiple lamp bodies
- ★ Use AC / DC12V power supply regardless of direction
- ★ High brightness, no stroboscopic, energy saving, long service life
- ★ The installation is convenient and safe, and can slide up and down in the track
- ★ It can be customized according to the requirements

- ★ 軌道式磁吸, 可驅動多個燈體
- ★ 使用AC/DC12V電源不分方向
- ★ 亮度高, 無頻閃, 節能省電, 使用壽命長
- ★ 安裝方便安全, 可以在道軌內上下滑動
- ★ 可按照要求定制

## Specification 產品規格

Model 型號	Voltage 電壓	Power 功率	Lumen Output 輸出流明	Color Rendering 顯色度	Colour Temp 色溫	Life Time 壽命	Beam Angle 光束角	Working temperature 工作溫度	Size 尺寸
	(V)	(W)	(lm/W)	(CRI)	(K)	(H)	(°)	(°C)	(mm)
ECBL-P1013-039C6	Dc12	3	80	>80	6000	30000	270	-20~45	300

Light efficiency (lm/W), Power (W), Color Rendering Index (CRI), Can be customized according to customer needs.

Our Standard Power factor (PF) > 0.9 and Total harmonic index THD < 15%, According to customer requirements can produce a lower THD < 10%.

This type of certification is issued by a government-approved laboratory for Safety certification, Fire testing, Restriction of Hazardous Substances (RoHS), Photobiological safety of lamps and lamp systems. (an Exemption Group) and other test certifications to ensure product quality

光效 (lm/W)、功率 (W)、顯色指數 (CRI), 可根據客戶需求定制。

此型號標準之功率因素 (PF) > 0.9, 總諧波指數 THD < 15%, 可按客戶需要生產低總諧波指數 < 10%。

此型號認證由可實驗室發出之安全認證消防測試, 環保物料 (RoHS), 光生物安全為 Exemption Group 及其它測試, 保證客戶使用更安心滿意。



# Mini Spotlight Magnetic Showcase Light

Series Type: EKBMM05

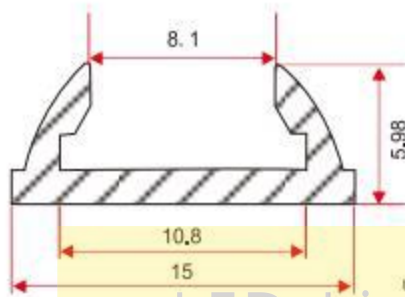

Unit: mm

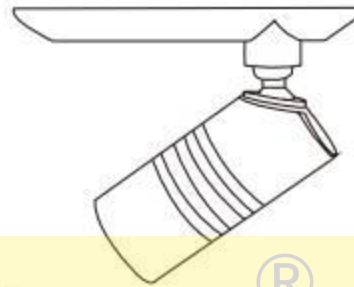

## Features 產品特點

- ★ Track type magnetic absorber can drive multiple lamp bodies
- ★ Use AC / DC12V power supply regardless of direction
- ★ High brightness, no stroboscopic, energy saving, long service life
- ★ The installation is convenient and safe, and can slide up and down in the track
- ★ It can be customized according to the requirements

- ★ 磁吸式, 安裝操作方便
- ★ 使用AC/DC12V電源不分方向
- ★ 亮度高, 無頻閃, 節能省電, 使用壽命長
- ★ 可以在道軌內上下滑動, 並可以根據需要調節出光方向
- ★ 適用: 珠寶櫃, 展示櫃
- ★ 可按照要求定制

## Specification 產品規格

Model 型號	Voltage 電壓 (V)	Power 功率 (W)	Lumen Output 輸出流明 (Lm/W)	Color Rendering 顯色度 (CRI)	Colour Temp 色溫 (K)	Life Time 壽命 (H)	Beam Angle 光束角 (°)	Working temperature 工作溫度 (°C)	Size 尺寸 (mm)
EKBL-E05-A4	AC/DC12	2	80	>80	4000	30000	10/25/45/60	-20~45	59.3*39.5*18.2
EKBL-E05-A3	AC/DC12	2	80	>80	3000	30000	10/25/45/60	-20~45	59.3*39.5*18.2

Light efficiency (lm/W), Power (W), Color Rendering Index (CRI), Can be customized according to customer needs.

Our Standard Power factor (PF) > 0.9 and Total harmonic index THD < 15%, According to customer requirements can produce a lower THD < 10%.

This type of certification is issued by a government-approved laboratory for Safety certification, Fire testing, Restriction of Hazardous Substances (RoHS), Photobiological safety of lamps and lamp systems. (an Exemption Group) and other test certifications to ensure product quality

光效 (lm/W)、功率 (W)、顯色指數 (CRI), 可根據客戶需求定制。

此型號標準之功率因素 (PF) > 0.9, 總諧波指數 THD < 15%, 可按客戶需要生產低總諧波指數 < 10%。

此型號認證由可實驗室發出之安全認證消防測試, 環保物料 (RoHS), 光生物安全為 Exemption Group 及其它測試, 保證客戶使用更安心滿意。

# Ultra Thin Rechargeable Body Induction Cabinet Lamp

Series Type: EKBIC04



## Features 產品特點

- ★ Integrated aviation aluminum material, high strength, corrosion resistance, good heat dissipation.
- ★ Using side light technology + high transmittance PMMA light guide plate and PC mask, the light is more uniform, soft and not dazzling.
- ★ Built in lithium battery and USB universal charging device, no need to dig holes and wiring, safe and convenient, easy to install.
- ★ Design of human body induction with light control
- ★ 採用一體式成型航空鋁材，高強度、耐腐蝕、散熱好。
- ★ 採用側發光技術+高透光性PMMA導光板及PC面罩，光線更均勻、柔和不刺眼。
- ★ 內置鋰電池及使用USB國際通用充電裝置，不用挖孔和佈線，安全便捷，安裝方便。
- ★ 帶光控人體感應設計

## Specification 產品規格

Model 型號	Voltage 電壓	Power 功率	Lumen-Output 輸出流明	Color Rendering 顯色度	Colour Temp 色溫	Life Time 壽命	Beam Angle 光束角	Working temperature 工作溫度	Size 尺寸
	(V)	(W)	(lm/W)	(CRI)	(K)	(H)	(°)	(°C)	(mm)
EKBL-E04-CA3	DC5V	2	80	>80	3000	10,000	120	-5~40	400*40*9

Light efficiency (lm/W), Power (W), Color Rendering Index (CRI), Can be customized according to customer needs.

Our Standard Power factor (PF) > 0.9 and Total harmonic index THD < 15%, According to customer requirements can produce a lower THD < 10%.

This type of certification is issued by a government-approved laboratory for Safety certification, Fire testing, Restriction of Hazardous Substances (RoHS), Photobiological safety of lamps and lamp systems. (an Exemption Group) and other test certifications to ensure product quality

光效 (lm/W)、功率 (W)、顯色指數 (CRI)，可根據客戶需求定制。

此型號標準之功率因素 (PF) > 0.9，總諧波指數 THD < 15%，可按客戶需要生產低總諧波指數 < 10%。

此型號認證由可實驗室發出之安全認證消防測試，環保物料 (RoHS)，光生物安全為 Exemption Group 及其它測試，保證客戶使用更安心滿意。



# Ultra Thin Rechargeable Body Induction Cabinet Lamp

Series Type: EKBIC06

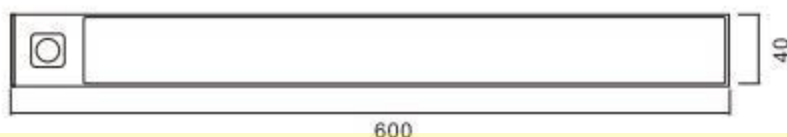

## Features 產品特點

- ★ Integrated aviation aluminum material, high strength, corrosion resistance, good heat dissipation.
- ★ Using side light technology + high transmittance PMMA light guide plate and PC mask, the light is more uniform, soft and not dazzling.
- ★ Built in lithium battery and USB universal charging device, no need to dig holes and wiring, safe and convenient, easy to install.
- ★ Design of human body induction with light control
- ★ 採用一體式成型航空鋁材，高強度、耐腐蝕、散熱好。
- ★ 採用側發光技術+高透光性PMMA導光板及PC面罩，光線更均勻、柔和不刺眼。
- ★ 內置鋰電池及使用USB國際通用充電裝置，不用挖孔和佈線，安全便捷，隨時隨地隨意安裝。
- ★ 帶光控人體感應設計

## Specification 產品規格

Model 型號	Voltage 電壓	Power 功率	Lumen Output 輸出流明	Color Rendering 顯色度	Colour Temp 色溫	Life Time 壽命	Beam Angle 光束角	Working temperature 工作溫度	Size 尺寸
	(V)	(W)	(lm)	(CRI)	(K)	(H)	(°)	(°C)	(mm)
EKBL-E06-A3	DC5V	3	80	>80	3000	10,000	120	-5~40	600*40*9

Light efficiency (lm/W), Power (W), Color Rendering Index (CRI), Can be customized according to customer needs.

Our Standard Power factor (PF) > 0.9 and Total harmonic index THD < 15%, According to customer requirements can produce a lower THD < 10%.

This type of certification is issued by a government-approved laboratory for Safety certification, Fire testing, Restriction of Hazardous Substances (RoHS), Photobiological safety of lamps and lamp systems. (an Exemption Group) and other test certifications to ensure product quality

光效 (lm/W)、功率 (W)、顯色指數 (CRI)，可根據客戶需求定制。

此型號標準之功率因素 (PF) > 0.9，總諧波指數 THD < 15%，可按客戶需要生產低總諧波指數 < 10%。

此型號認證由可實驗室發出之安全認證消防測試，環保物料 (RoHS)，光生物安全為 Exemption Group 及其它測試，保證客戶使用更安心滿意。



# 10 \* 10 Embedded Flexible Silicone Lamp Belt

Series Type: ELBEG10

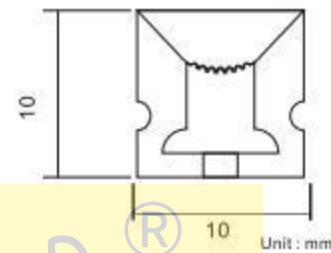

## Features 產品特點

- ★ 1) Insulation, flame retardant, safe and durable
- ★ High light transmittance, corrosion resistance and bending resistance
- ★ Waterproof and moisture-proof

- ★ 絕緣阻燃安全呢耐用
- ★ 高透光抗腐蝕耐折彎
- ★ 防水防潮

## Specification 產品規格

Model 型號	Voltage 電壓	Power 功率	Lumen Output 輸出流明	Color Rendering 顯色度	Colour Temp 色溫	Life Time 壽命	Beam Angle 光束角	Working temperature 工作溫度	Size 尺寸
	(V)	(W)	(lm/W)	(CRI)	(K)	(H)	(°)	(°C)	(mm)
ESLB-1010A3	24	8	50	>80	3000	30000	120	-20~45	1000
ESLB-1010A4	24	8	50	>80	4000	30000	120	-20~45	1000
ESLB-1010A6	24	8	50	>80	6000	30000	120	-20~45	1000

Light efficiency (lm/W), Power (W), Color Rendering Index (CRI), Can be customized according to customer needs.

Our Standard Power factor (PF) > 0.9 and Total harmonic index THD < 15%, According to customer requirements can produce a lower THD < 10%.

This type of certification is issued by a government-approved laboratory for Safety certification, Fire testing, Restriction of Hazardous Substances (RoHS), Photobiological safety of lamps and lamp systems, (an Exemption Group) and other test certifications to ensure product quality

光效 (lm/W)、功率 (W)、顯色指數 (CRI), 可根據客戶需求定制。

此型號標準之功率因素 (PF) > 0.9, 總諧波指數 THD < 15%, 可按客戶需要生產低總諧波指數 < 10%。

此型號認證由可實驗室發出之安全認證消防測試, 環保物料 (RoHS), 光生物安全為 Exemption Group 及其它測試, 保證客戶使用更安心滿意。

## 12\*12嵌入式柔性硅膠燈帶



# 12 \* 12 Embedded Flexible Silicone Lamp Belt

Series Type: ELBEG12

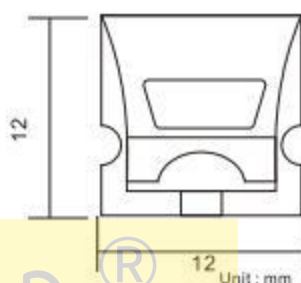

### Features 產品特點

- ★ 1) Insulation, flame retardant, safe and durable
- ★ High light transmittance, corrosion resistance and bending resistance
- ★ Waterproof and moisture-proof

- ★ 絕緣阻燃安全呢耐用
- ★ 高透光抗腐蝕耐折彎
- ★ 防水防潮

12

### Specification 產品規格

Model 型號	Voltage 電壓 (V)	Power 功率 (W)	Lumen Output 輸出流明 (Lm/W)	Color Rendering 顯色度 (CRI)	Colour Temp 色溫 (K)	Life Time 壽命 (H)	Beam Angle 光束角 (°)	Working temperature 工作溫度 (°C)	Size 尺寸 (mm)
ESLB-NL-1212A3	24	8	50	>80	3000	30000	120	-20~45	1000
ESLB-NL-1212A3	24	8	50	>80	4000	30000	120	-20~45	1000
ESLB-NL-1212A3	24	8	50	>80	6000	30000	120	-20~45	1000

Light efficiency (lm/W), Power (W), Color Rendering Index (CRI), Can be customized according to customer needs.

Our Standard Power factor (PF) > 0.9 and Total harmonic index THD < 15%, According to customer requirements can produce a lower THD < 10%.

This type of certification is issued by a government-approved laboratory for Safety certification, Fire testing, Restriction of Hazardous Substances (RoHS), Photobiological safety of lamps and lamp systems, (an Exemption Group) and other test certifications to ensure product quality

光效 (lm/W)、功率 (W)、顯色指數 (CRI)，可根據客戶需求定制。

此型號標準之功率因素 (PF) > 0.9，總諧波指數 THD < 15%，可按客戶需要生產低總諧波指數 < 10%。

此型號認證由可實驗室發出之安全認證消防測試，環保物料 (RoHS)，光生物安全為 Exemption Group 及其它測試，保證客戶使用更安心滿意。



## A1013 Aluminum Lamp Strip Cabinet Lamp

Series Type: EAL1013

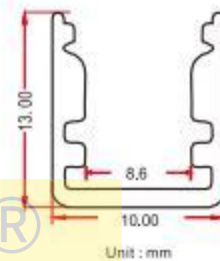

## Features 產品特點

- ★ Size: 10mm (W) \* 13mm (H)
- ★ PC cover: milky white
- ★ Use SPM design - power circuit protection to cut off a single LED in case of failure
- ★ Aluminum frame for maximum heat dissipation
- ★ Series mounted for seamless lighting output
- ★ Uniform light emission, no LED light spot
- ★ Application: cabinet, bathroom cabinet, wardrobe, display cabinet, retail store, etc

- ★ 尺寸: 10毫米(寬) \* 13毫米(高)
- ★ PC蓋: 乳白色
- ★ 使用SPM設計-電源電路保護, 故障時切斷單個LED
- ★ 採用鋁框架使散熱最大化
- ★ 串聯安裝以實現無縫照明輸出
- ★ 發光均勻, 無LED光點
- ★ 應用: 櫥櫃、浴室櫃、衣櫃、展示櫃、零售店等

## Specification 產品規格

Model 型號	Voltage 電壓	Power 功率	Lumen Output 輸出流明	Color Rendering 顯色度	Colour Temp 色溫	Life Time 壽命	Beam Angle 光束角	Working Temperature 工作溫度	Size 尺寸
	(V)	(W)	(Lm/W)	(CRI)	(K)	(H)	(°)	(°C)	(mm)
ECBL-A1013	24V	8	100	>80	3000	30000	120	-20~45	1000*10*13

Light efficiency (lm/W), Power (W), Color Rendering Index (CRI), Can be customized according to customer needs.

Our Standard Power factor (PF) > 0.9 and Total harmonic index THD < 15%, According to customer requirements can produce a lower THD < 10%.

This type of certification is issued by a government-approved laboratory for Safety certification, Fire testing, Restriction of Hazardous Substances (RoHS), Photobiological safety of lamps and lamp systems. (an Exemption Group) and other test certifications to ensure product quality

光效 (lm/W)、功率 (W)、顯色指數 (CRI), 可根據客戶需求定制。

此型號標準之功率因素 (PF) > 0.9, 總諧波指數 THD < 15%, 可按客戶需要生產低總諧波指數 < 10%。

此型號認證由可實驗室發出之安全認證消防測試, 環保物料 (RoHS), 光生物安全為 Exemption Group 及其它測試, 保證客戶使用更安心滿意。

## A3030 ALUMINUM LAMP Strip Cabinet Lamp

Series Type: EAL3030

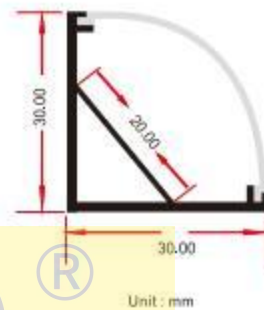

## Features 產品特點

- ★ Size: 30mm (W) \* 30MM (H)
- ★ PC cover: milky white or transparent
- ★ Use SPM design - power circuit protection to cut off a single LED in case of failure
- ★ Aluminum frame for maximum heat dissipation
- ★ Series mounted for seamless lighting output
- ★ Uniform light emission, no LED light spot
- ★ Application: cabinet, bathroom cabinet, wardrobe, display cabinet, retail store, etc

- ★ 尺寸:30毫米(寬)\*30毫米(高)
- ★ PC蓋:乳白色或透明
- ★ 使用SPM設計-電源電路保護,故障時切斷單個LED
- ★ 採用鋁框架使散熱最大化
- ★ 串聯安裝以實現無縫照明輸出
- ★ 發光均勻,無LED光點
- ★ 應用:櫥櫃、浴室櫃、衣櫃、展示櫃、零售店等

## Specification 產品規格

Model 型號	Voltage 電壓	Power 功率	Lumen Output 輸出流明	Color Rendering 顯色度	Colour Temp 色溫	Life Time 壽命	Beam Angle 光束角	Working temperature 工作溫度	Size 尺寸
	(V)	(W)	(Lm/W)	(CRI)	(K)	(H)	(°)	(°C)	(mm)
ECBL-A3030	24V	12	100	>80	3000	30000	120	-20~45	1000*30*30

Light efficiency (lm/W), Power (W), Color Rendering Index (CRI), Can be customized according to customer needs.

Our Standard Power factor (PF) > 0.9 and Total harmonic index THD < 15%, According to customer requirements can produce a lower THD < 10%.

This type of certification is issued by a government-approved laboratory for Safety certification, Fire testing, Restriction of Hazardous Substances (RoHS), Photobiological safety of lamps and lamp systems. (an Exemption Group) and other test certifications to ensure product quality

光效 (lm/W)、功率 (W)、顯色指數 (CRI), 可根據客戶需求定制。

此型號標準之功率因素 (PF) > 0.9, 總諧波指數 THD < 15%, 可按客戶需要生產低總諧波指數 < 10%。

此型號認證由可實驗室發出之安全認證消防測試, 環保物料 (RoHS), 光生物安全為 Exemption Group 及其它測試, 保證客戶使用更安心滿意。



## A1418 ALUMINUM LAMP Strip Cabinet Lamp

Series Type: EAL1418

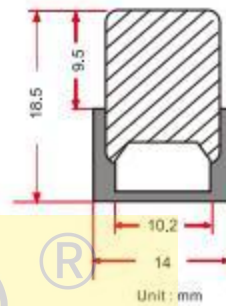

## Features 產品特點

- ★ Size: 14 mm (W) \* 18.5 mm (H)
- ★ PC cover: milky white
- ★ Use SPM design - power circuit protection to cut off a single LED in case of failure
- ★ Aluminum frame for maximum heat dissipation
- ★ Series mounted for seamless lighting output
- ★ Uniform light emission, no LED light spot
- ★ Application: cabinet, bathroom cabinet, wardrobe, display cabinet, retail store, etc

- ★ 尺寸:14毫米(寬)\*18.5毫米(高)
- ★ PC蓋:乳白色
- ★ 使用SPM設計-電源電路保護,故障時切斷單個LED
- ★ 採用鋁框架使散熱最大化
- ★ 串聯安裝以實現無縫照明輸出
- ★ 發光均勻,無LED光點
- ★ 應用:櫥櫃、浴室櫃、衣櫃、展示櫃、零售店等

## Specification 產品規格

Model 型號	Voltage 電壓	Power 功率	Lumen Output 輸出流明	Color Rendering 顯色度	Colour Temp 色溫	Life Time 壽命	Beam Angle 光束角	Working temperature 工作溫度	Size 尺寸
	(V)	(W)	(Lm/W)	(CRI)	(K)	(H)	(°)	(°C)	(mm)
ECBL-A1418	24V	8	100	>80	3000	30000	180	-20~45	1000*14*18.5

Light efficiency (lm/W), Power (W), Color Rendering Index (CRI), Can be customized according to customer needs.

Our Standard Power factor (PF) > 0.9 and Total harmonic index THD < 15%, According to customer requirements can produce a lower THD < 10%.

This type of certification is issued by a government-approved laboratory for Safety certification, Fire testing, Restriction of Hazardous Substances (RoHS), Photobiological safety of lamps and lamp systems. (an Exemption Group) and other test certifications to ensure product quality

光效 (lm/W)、功率 (W)、顯色指數 (CRI), 可根據客戶需求定制。

此型號標準之功率因素 (PF) > 0.9, 總諧波指數 THD < 15%, 可按客戶需要生產低總諧波指數 < 10%。

此型號認證由可實驗室發出之安全認證消防測試, 環保物料 (RoHS), 光生物安全為 Exemption Group 及其它測試, 保證客戶使用更安心滿意。

## A2008 ALUMINUM LAMP Strip Cabinet Lamp

Series Type: EAL2008

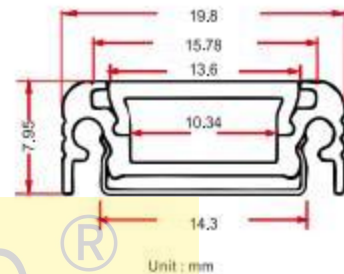

## Features 產品特點

- ★ Size: 19.8mm (W) \* 8mm (H)
- ★ PC cover: milky white or transparent
- ★ Use SPM design - power circuit protection to cut off a single LED in case of failure
- ★ Aluminum frame for maximum heat dissipation
- ★ Series mounted for seamless lighting output
- ★ Uniform light emission, no LED light spot
- ★ Application: cabinet, bathroom cabinet, wardrobe, display cabinet, retail store, etc

- ★ 尺寸: 19.8毫米(寬)\*8毫米(高)
- ★ PC蓋: 乳白色或透明
- ★ 使用SPM設計-電源電路保護, 故障時切斷單個LED
- ★ 採用鋁框架使散熱最大化
- ★ 串聯安裝以實現無縫照明輸出
- ★ 發光均勻, 無LED光點
- ★ 應用: 櫥櫃、浴室櫃、衣櫃、展示櫃、零售店等

## Specification 產品規格

Model 型號	Voltage 電壓	Power 功率	Lumen Output 輸出流明	Color Rendering 顯色度	Colour Temp 色溫	Life Time 壽命	Beam Angle 光束角	Working temperature 工作溫度	Size 尺寸
	(V)	(W)	(Lm/W)	(CRI)	(K)	(H)	(°)	(°C)	(mm)
ECBL-A2008	24V	8	100	>80	3000	30000	120	-20~45	1000*19.8*8

Light efficiency (lm/W), Power (W), Color Rendering Index (CRI), Can be customized according to customer needs.

Our Standard Power factor (PF) > 0.9 and Total harmonic index THD < 15%, According to customer requirements can produce a lower THD < 10%.

This type of certification is issued by a government-approved laboratory for Safety certification, Fire testing, Restriction of Hazardous Substances (RoHS), Photobiological safety of lamps and lamp systems. (an Exemption Group) and other test certifications to ensure product quality

光效 (lm/W)、功率 (W)、顯色指數 (CRI), 可根據客戶需求定制。

此型號標準之功率因素 (PF) > 0.9, 總諧波指數 THD < 15%, 可按客戶需要生產低總諧波指數 < 10%。

此型號認證由可實驗室發出之安全認證消防測試, 環保物料 (RoHS), 光生物安全為 Exemption Group 及其它測試, 保證客戶使用更安心滿意。



## C2310L Aluminum Lamp Strip Cabinet Lamp

Series Type: EAC2310

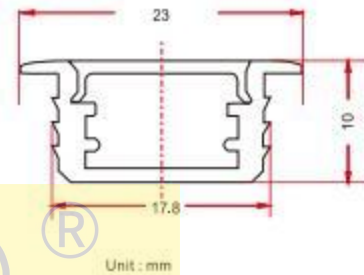

## Features 產品特點

- ★ Lamp body material: Aviation 6063 aluminum
- ★ Size: 23mm (height) x10mm (height)
- ★ LED cold light source, pure light color, very good display effect
- ★ High light transmittance, non dazzling, natural light color and uniform light
- ★ High thermal conductivity aluminum based PCB board is adopted, with low calorific value and good heat dissipation
- ★ It is applicable to the lighting of cabinets, wine cabinets, wardrobe, display cabinets, lockers and other furniture

- ★ 燈體材料：航空6063鋁
- ★ 尺寸：23毫米(寬)X10毫米(高)
- ★ LED冷光源，光色純正，非常好的展示效果
- ★ 高透光，不刺眼，光色自然，光線均勻
- ★ 採用高導熱鋁基PCB板，發熱量低，散熱好
- ★ 適用於櫥櫃、酒櫃、衣櫃、展示櫃、儲物櫃等家具照明

## Specification 產品規格

Model 型號	Voltage 電壓	Power 功率	Lumen Output 輸出流明	Color Rendering 顯色度	Colour Temp 色溫	Life Time 壽命	Beam Angle 光束角	Working temperature 工作溫度	Size 尺寸
	(V)	(W)	(lm/W)	(CRI)	(K)	(H)	(°)	(°C)	(mm)
ECBL-A2310	Dc12	12	100	>80	3000	30000	120	-20~45	1000*23*10

Light efficiency (lm/W), Power (W), Color Rendering Index (CRI), Can be customized according to customer needs.

Our Standard Power factor (PF) > 0.9 and Total harmonic index THD < 15%, According to customer requirements can produce a lower THD < 10%.

This type of certification is issued by a government-approved laboratory for Safety certification, Fire testing, Restriction of Hazardous Substances (RoHS), Photobiological safety of lamps and lamp systems. (an Exemption Group) and other test certifications to ensure product quality

光效 (lm/W)、功率 (W)、顯色指數 (CRI)，可根據客戶需求定制。

此型號標準之功率因素 (PF) > 0.9，總諧波指數 THD < 15%，可按客戶需要生產低總諧波指數 < 10%。

此型號認證由可實驗室發出之安全認證消防測試，環保物料 (RoHS)，光生物安全為 Exemption Group 及其它測試，保證客戶使用更安心滿意。

## C2408L Aluminum Lamp Strip Cabinet Lamp

Series Type: EAC2408

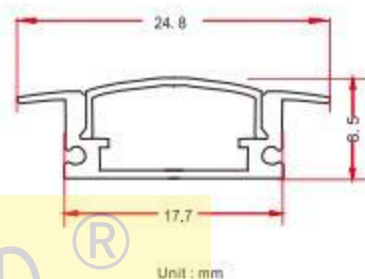

Unit: mm

## Features 產品特點

- ★ Lamp body material: Aviation 6063 aluminum
- ★ Size: 24.8 mm x 8.5 mm high
- ★ Micro arc light-emitting cover with larger brightening surface
- ★ The lamp body is smooth, high brightness, light and ultra-thin
- ★ Anti UV, no yellow, high light transmittance
- ★ It is applicable to the lighting of cabinets, wine cabinets, wardrobe, display cabinets, lockers and other furniture

- ★ 燈體材料：航空6063鋁
- ★ 尺寸：24.8毫米(寬)X8.5毫米(高)
- ★ 微弧型發光罩，亮化面更大
- ★ 燈體光滑，亮度高，輕質超薄
- ★ 抗UV紫外線不要黃，高透光
- ★ 適用於櫥櫃、酒櫃、衣櫃、展示櫃、儲物櫃等家具照明

## Specification 產品規格

Model 型號	Voltage 電壓	Power 功率	Lumen Output 輸出流明	Color Rendering 顯色度	Colour Temp 色溫	Life Time 壽命	Beam Angle 光束角	Working temperature 工作溫度	Size 尺寸
	(V)	(W)	(Lm/W)	(CRI)	(K)	(H)	(°)	(°C)	(mm)
ECBL-A2408	Dc12	12	100	>80	3000	30000	120	-20~45	1000*24.8*8.5

Light efficiency (lm/W), Power (W), Color Rendering Index (CRI), Can be customized according to customer needs.

Our Standard Power factor (PF) > 0.9 and Total harmonic index THD < 15%, According to customer requirements can produce a lower THD < 10%.

This type of certification is issued by a government-approved laboratory for Safety certification, Fire testing, Restriction of Hazardous Substances (RoHS), Photobiological safety of lamps and lamp systems. (an Exemption Group) and other test certifications to ensure product quality

光效 (lm/W)、功率 (W)、顯色指數 (CRI)，可根據客戶需求定制。

此型號標準之功率因素 (PF) > 0.9，總諧波指數 THD < 15%，可按客戶需要生產低總諧波指數 < 10%。

此型號認證由可實驗室發出之安全認證消防測試，環保物料 (RoHS)，光生物安全為 Exemption Group 及其它測試，保證客戶使用更安心滿意。



## C1712L Aluminum Lamp Strip Cabinet Lamp

Series Type: EAC1712

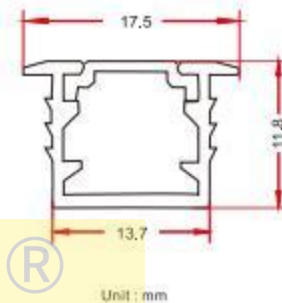

## Features 產品特點

- ★ Lamp body material: Aviation 6063 aluminum
- ★ Size: 17,5mm (height) x11,8mm (height)
- ★ Round plug, flat plug, multicolor aluminum, more perfect with furniture decoration
- ★ Uniform lighting, no dark area, and the lighting in the cabinet is preferred
- ★ The whole lamp surface is anodized, which is more durable. The lamp body is serrated and installed more firmly
- ★ It is applicable to the lighting of cabinets, wine cabinets, wardrobe, display cabinets, lockers and other furniture

- ★ 燈體材料：航空6063鋁
- ★ 尺寸：17.5毫米(寬)X11.8毫米(高)
- ★ 圓堵頭，平堵頭，多色鋁材，更完美搭配家具裝飾
- ★ 發光均勻，無暗區，櫃內燈光首選
- ★ 整燈表面陽極氧化，更耐用，燈體呈鋸齒狀，安裝更牢固
- ★ 適用於櫥櫃、酒櫃、衣櫃、展示櫃、儲物櫃等家具照明

## Specification 產品規格

Model 型號	Voltage 電壓	Power 功率	Lumen Output 輸出流明	Color Rendering 顯色度	Colour Temp 色溫	Life Time 壽命	Bears Angle 光束角	Working temperature 工作溫度	Size 尺寸
	(V)	(W)	(Lm/W)	(CRI)	(K)	(H)	(°)	(°C)	(mm)
ECBL-A1712	Dc12	8	100	>80	3000	30000	120	-20~45	1000*17.5*11.8

Light efficiency (lm/W), Power (W), Color Rendering Index (CRI), Can be customized according to customer needs.

Our Standard Power factor (PF) > 0.9 and Total harmonic index THD < 15%, According to customer requirements can produce a lower THD < 10%.

This type of certification is issued by a government-approved laboratory for Safety certification, Fire testing, Restriction of Hazardous Substances (RoHS), Photobiological safety of lamps and lamp systems. (an Exemption Group) and other test certifications to ensure product quality

光效 (lm/W)、功率 (W)、顯色指數 (CRI)，可根據客戶需求定制。

此型號標準之功率因素 (PF) > 0.9，總諧波指數 THD < 15%，可按客戶需要生產低總諧波指數 < 10%。

此型號認證由可實驗室發出之安全認證消防測試，環保物料 (RoHS)，光生物安全為 Exemption Group 及其它測試，保證客戶使用更安心滿意。

## S5050 SMT Monochrome Strip

Series Type: ELBSM50

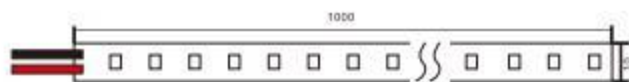

Unit : mm

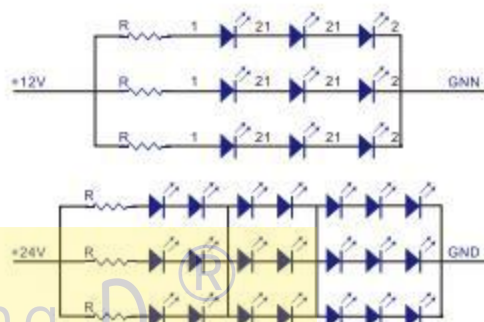

## Features 產品特點

- ★ High brightness patch 5050 LED is used as high brightness wide viewing angle light source
- ★ The bottom plate adopts double-sided imported calendered copper FPC, with good folding resistance and strong overcurrent capacity
- ★ Led quantity: 60pcs / M
- ★ Ultra low power consumption, only 0.6 w each
- ★ The optical design is reasonable, without spot and stroboscopic
- ★ Suitable for indoor installation

- ★ 採用高亮度貼片5050 LED作為高亮度寬視角光源
- ★ 底板採用雙面進口壓延銅FPC, 抗折性好, 過電流能力強
- ★ LED數量: 60PCS/M
- ★ 超低功耗, 每壹僅0.6瓦
- ★ 光學設計合理, 無光斑, 無頻閃
- ★ 適用於室內安裝

## Specification 產品規格

Model 型號	Voltage 電壓	Power 功率	Lumen Output 輸出流明	Color Rendering 顯色度	Colour Temp 色溫	Life Time 壽命	Beam Angle 光束角	Working temperature 工作溫度	Size 尺寸
	(V)	(W)	(Lm/W)	(CRI)	(K)	(H)	(°)	(°C)	(mm)
ESLB-S14-108B3	DC12/24	14	80	>80	3000	30000	120	-20~45	1000*10*6

Light efficiency (lm/W), Power (W), Color Rendering Index (CRI), Can be customized according to customer needs.

Our Standard Power factor (PF) > 0.9 and Total harmonic index THD < 15%, According to customer requirements can produce a lower THD < 10%.

This type of certification is issued by a government-approved laboratory for Safety certification, Fire testing, Restriction of Hazardous Substances (RoHS), Photobiological safety of lamps and lamp systems. (an Exemption Group) and other test certifications to ensure product quality

光效 (lm/W)、功率 (W)、顯色指數 (CRI), 可根據客戶需求定制。

此型號標準之功率因素 (PF) > 0.9, 總諧波指數 THD < 15%, 可按客戶需要生產低總諧波指數 < 10%。

此型號認證由可實驗室發出之安全認證消防測試, 環保物料 (RoHS), 光生物安全為 Exemption Group 及其它測試, 保證客戶使用更安心滿意。



# 2835 Chip Waterproof Glue Lamp Strip

Series Type: ELBIP50



Unit : mm

## Features 產品特點

- ★ High brightness patch 2835 LED is used as high brightness wide viewing angle light source
  - ★ The bottom plate adopts double-sided imported pressed PVC
  - ★ Led quantity: 120pcs / M
  - ★ Beam angle 120 degrees
  - ★ Ultra low power consumption, only 0.6 w each
  - ★ The optical design is reasonable, without spot and stroboscopic
  - ★ Good waterproof, suitable for indoor and outdoor installation
- ★ 採用高亮度貼片2835 LED作為高亮度寬視角光源
  - ★ 底板採用雙面進口壓PVC
  - ★ LED數量：120PCS/M
  - ★ 光束角度120度
  - ★ 超低功耗，每壹僅0.6瓦
  - ★ 光學設計合理，無光斑，無頻閃
  - ★ 防水性好，適用於室內和室外安裝

## Specification 產品規格

Model 型號	Voltage 電壓	Power 功率	Lumen Output 輸出流明	Color Rendering 顯色度	Colour Temp 色溫	Life Time 壽命	Beam Angle 光束角	Working temperature 工作溫度	Size 尺寸
	(V)	(W)	(Lm/M)	(CRI)	(K)	(H)	(°)	(°C)	(mm)
ESLB-S14-108A3-IP	12	14	100	>80	3000	20000	120	-20~45	1000*16*8

Light efficiency (lm/W), Power (W), Color Rendering Index (CRI), Can be customized according to customer needs.

Our Standard Power factor (PF) > 0.9 and Total harmonic index THD < 15%, According to customer requirements can produce a lower THD < 10%.

This type of certification is issued by a government-approved laboratory for Safety certification, Fire testing, Restriction of Hazardous Substances (RoHS), Photobiological safety of lamps and lamp systems. (an Exemption Group) and other test certifications to ensure product quality

光效 (lm/W)、功率 (W)、顯色指數 (CRI)，可根據客戶需求定制。

此型號標準之功率因素 (PF) > 0.9，總諧波指數 THD < 15%，可按客戶需要生產低總諧波指數 < 10%。

此型號認證由可實驗室發出之安全認證消防測試，環保物料 (RoHS)，光生物安全為 Exemption Group 及其它測試，保證客戶使用更安心滿意。

# 2835 Chip RGB Three Color Waterproof Lamp Strip

Series Type: ELBGB50

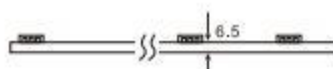

Unit : mm

## Features 產品特點

- ★ High brightness patch 2835 LED is used as high brightness wide viewing angle light source
- ★ The bottom plate adopts double-sided imported pressed PVC, which has very good resistance
- ★ Led quantity: 60pcs / M
- ★ Beam angle: 120°
- ★ Ultra low power consumption, only 0.6 w each
- ★ The optical design is reasonable, without spot and stroboscopic
- ★ Aluminum trough is easy to install
- ★ Good waterproof, suitable for indoor and outdoor installation

- ★ 採用高亮度貼片2835 LED作為高亮度寬視角光源
- ★ 底板採用雙面進口壓PVC, 耐性非常好
- ★ LED數量: 60PCS/M
- ★ 光束角度: 120°
- ★ 超低功耗, 每壹僅0.6瓦
- ★ 光學設計合理, 無光斑, 無頻閃
- ★ 鋁槽安裝方便
- ★ 防水性好, 適用於室內和室外安裝

## Specification 產品規格

Model 型號	Voltage 電壓	Power 功率	Lumen Output 輸出流明	Color Rendering 顯色度	Colour Temp 色溫	Life Time 壽命	Beam Angle 光束角	Working temperature 工作溫度	Size 尺寸
	(V)	(W)	(Lm/W)	(CRI)	(K)	(H)	(°)	(°C)	(mm)
ESLB-RGB14-108A-IP	DC12/24	13.5	100	>80	RGB	20000	120	-20~45	1000*13.5*6.5

Light efficiency (lm/W), Power (W), Color Rendering Index (CRI), Can be customized according to customer needs.

Our Standard Power factor (PF) > 0.9 and Total harmonic index THD < 15%, According to customer requirements can produce a lower THD < 10%.

This type of certification is issued by a government-approved laboratory for Safety certification, Fire testing, Restriction of Hazardous Substances (RoHS), Photobiological safety of lamps and lamp systems. (an Exemption Group) and other test certifications to ensure product quality

光效 (lm/W)、功率 (W)、顯色指數 (CRI), 可根據客戶需求定制。

此型號標準之功率因素 (PF) > 0.9, 總諧波指數 THD < 15%, 可按客戶需要生產低總諧波指數 < 10%。

此型號認證由可實驗室發出之安全認證消防測試, 環保物料 (RoHS), 光生物安全為 Exemption Group 及其它測試, 保證客戶使用更安心滿意。



# 2835 chip two-color Waterproof Lamp Strip

Series Type: ELBDI50

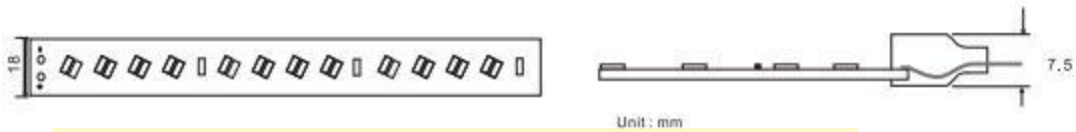

## Features 產品特點

- ★ High brightness patch 2835 LED is used as high brightness wide viewing angle light source
- ★ The bottom plate adopts double-sided imported pressed PVC, which has very good resistance
- ★ Led quantity: 120pcs / M
- ★ Beam angle: 120°
- ★ Ultra low power consumption, only 0.6 w each
- ★ The optical design is reasonable, without spot and stroboscopic
- ★ Aluminum trough is easy to install
- ★ Good waterproof, suitable for indoor and outdoor installation

## Specification 產品規格

Model 型號	Voltage 電壓	Power 功率	Lumen Output 輸出流明	Color Rendering 顯色度	Colour Temp 色溫	Life Time 壽命	Beam Angle 光束角	Working temperature 工作溫度	Size 尺寸
	(V)	(W)	(Lm/M)	(CRI)	(K)	(H)	(°)	(°C)	(mm)
ESLB-D14-108A-IP65	DC12/24	13.5	100	>80	3000	20000	120	-20~45	1000*18*7.5

Light efficiency (lm/W), Power (W), Color Rendering Index (CRI), Can be customized according to customer needs.

Our Standard Power factor (PF) > 0.9 and Total harmonic index THD < 15%, According to customer requirements can produce a lower THD < 10%.

This type of certification is issued by a government-approved laboratory for Safety certification, Fire testing, Restriction of Hazardous Substances (RoHS), Photobiological safety of lamps and lamp systems. (an Exemption Group) and other test certifications to ensure product quality

光效 (lm/W)、功率 (W)、顯色指數 (CRI)，可根據客戶需求定制。

此型號標準之功率因素 (PF) > 0.9，總諧波指數 THD < 15%，可按客戶需要生產低總諧波指數 < 10%。

此型號認證由可實驗室發出之安全認證消防測試，環保物料 (RoHS)，光生物安全為 Exemption Group 及其它測試，保證客戶使用更安心滿意。

## T5 Waterproof Neon Light

Series Type: ELBNLT5

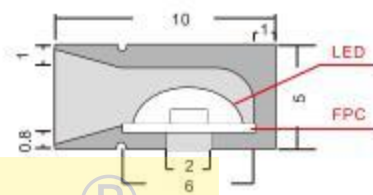
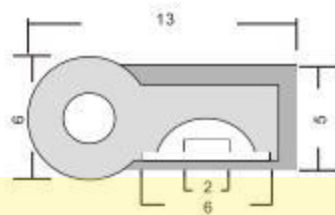
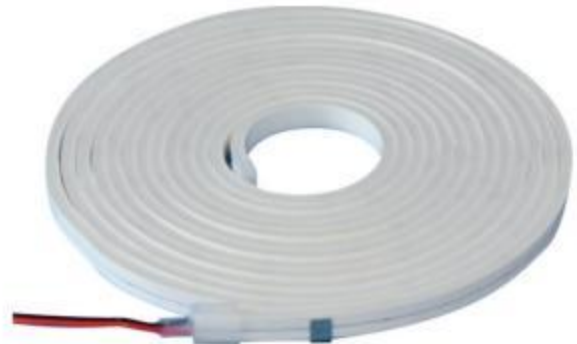

## Features 產品特點

- ★ High brightness patch 2835 LED is used as high brightness wide viewing angle light source
- ★ Silicone material, weather resistance is very good
- ★ Led quantity: 120pcs / M
- ★ Hollow design, good heat dissipation
- ★ It can be cut at will
- ★ The plug is specially designed to facilitate modeling and docking, and there is no dark area for docking
- ★ The light band is very soft, easy to install and any shape
- ★ Suitable for indoor and outdoor

- ★ 採用高亮度贴片2835 LED作為高亮度廣視角光源
- ★ 硅膠材質，耐候性非常好
- ★ LED數量：120PCS/M
- ★ 鏤空設計，散熱性好
- ★ 可以任意裁剪
- ★ 堵頭特殊設計，方便造型對接，對接無暗區
- ★ 燈帶非常柔軟，方便安裝以及任意造型
- ★ 適用於室內和室外

## Specification 產品規格

Model 型號	Voltage 電壓 (V)	Power 功率 (W)	Lumen Output 輸出流明 (Lm/M)	Color Rendering 顯色度 (CRI)	Colour Temp 色溫 (K)	Life Time 壽命 (H)	Beam Angle 光束角 (°)	Working temperature 工作溫度 (°C)	Size 尺寸 (cm)
ESLB-NL-T5	12/24	9.6	100	>80	3000	20000	270	-20~45	1000*5*10

Light efficiency (lm/W), Power (W), Color Rendering Index (CRI), Can be customized according to customer needs.

Our Standard Power factor (PF) > 0.9 and Total harmonic index THD < 15%, According to customer requirements can produce a lower THD < 10%.

This type of certification is issued by a government-approved laboratory for Safety certification, Fire testing, Restriction of Hazardous Substances (RoHS), Photobiological safety of lamps and lamp systems. (an Exemption Group) and other test certifications to ensure product quality

光效 (lm/W)、功率 (W)、顯色指數 (CRI)，可根據客戶需求定制。

此型號標準之功率因素 (PF) > 0.9，總諧波指數 THD < 15%，可按客戶需要生產低總諧波指數 < 10%。

此型號認證由可實驗室發出之安全認證消防測試，環保物料 (RoHS)，光生物安全為 Exemption Group 及其它測試，保證客戶使用更安心滿意。



## T10 Waterproof Neon Light

Series Type: ELBNT10

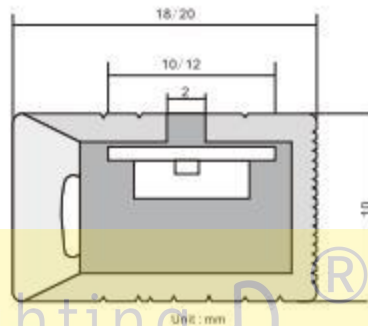

## Features 產品特點

- ★ High brightness patch 2835 LED is used as high brightness wide viewing angle light source
- ★ Silicone material, weather resistance is very good
- ★ Led quantity: 60PCS/M
- ★ Hollow design, good heat dissipation
- ★ It can be cut at will
- ★ The plug is specially designed to facilitate modeling and docking, and there is no dark area for docking
- ★ The light band is very soft, easy to install and any shape
- ★ Suitable for indoor and outdoor

- ★ 採用高亮度貼片2835 LED作為高亮度廣視角光源
- ★ 矽膠材質，耐候性非常好
- ★ LED數量→60PCS/M
- ★ 鏤空設計，散熱性好
- ★ 可以任意裁剪
- ★ 堵頭特殊設計，方便造型對接，對接無暗區
- ★ 燈帶非常柔軟，方便安裝以及任意造型
- ★ 適用於室內和室外

## Specification 產品規格

Model 型號	Voltage 電壓	Power 功率	Lumen Output 輸出流明	Color Rendering 顯色度	Colour Temp 色溫	Life Time 壽命	Beam Angle 光束角	Working temperature 工作溫度	Size 尺寸
	(V)	(W)	(Lm/M)	(CRI)	(K)	(H)	(°)	(°C)	(mm)
ESLB-NL-T10	12/24	9.6	100	>80	3000	20000	120	-20~45	1000*10*18

Light efficiency (lm/W), Power (W), Color Rendering Index (CRI), Can be customized according to customer needs.

Our Standard Power factor (PF) > 0.9 and Total harmonic index THD < 15%, According to customer requirements can produce a lower THD < 10%.

This type of certification is issued by a government-approved laboratory for Safety certification, Fire testing, Restriction of Hazardous Substances (RoHS), Photobiological safety of lamps and lamp systems. (an Exemption Group) and other test certifications to ensure product quality

光效 (lm/W)、功率 (W)、顯色指數 (CRI)，可根據客戶需求定制。

此型號標準之功率因素 (PF) > 0.9，總諧波指數 THD < 15%，可按客戶需要生產低總諧波指數 < 10%。

此型號認證由可實驗室發出之安全認證消防測試，環保物料 (RoHS)，光生物安全為 Exemption Group 及其它測試，保證客戶使用更安心滿意。

## T15 Waterproof Neon Light

Series Type: ELBNT15

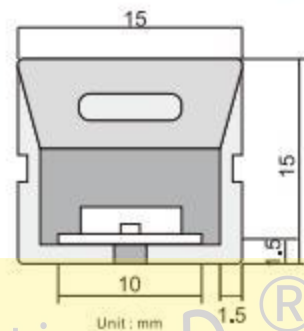

## Features 產品特點

- ★ High brightness patch 2835 LED is used as high brightness wide viewing angle light source
- ★ Silicone material, weather resistance is very good
- ★ Led quantity: 120PCS/M
- ★ Hollow design, good heat dissipation
- ★ It can be cut at will
- ★ The plug is specially designed to facilitate modeling and docking, and there is no dark area for docking
- ★ The light band is very soft, easy to install and any shape
- ★ Suitable for indoor and outdoor

- ★ 採用高亮度贴片2835 LED作為高亮度寬視角光源
- ★ 硅膠材質，耐候性非常好
- ★ LED數量：120PCS/M
- ★ 鏤空設計，散熱性好
- ★ 可以任意裁剪
- ★ 堵頭特殊設計，方便造型對接，對接無暗區
- ★ 燈帶非常柔軟，方便安裝以及任意造型
- ★ 適用於室內和室外

## Specification 產品規格

Model 型號	Voltage 電壓	Power 功率	Lumen Output 輸出流明	Color Rendering 顯色度	Colour Temp. 色溫	Life Time 壽命	Beam Angle 光束角	Working temperature 工作溫度	Size 尺寸
	(V)	(W)	(lm/W)	(CRI)	(K)	(H)	(°)	(°C)	(mm)
ESLB-NL-T15	12/24	9.6	100	>80	3000	20000	120	-20~45	1000*15*15

Light efficiency (lm/W), Power (W), Color Rendering Index (CRI), Can be customized according to customer needs.

Our Standard Power factor (PF) > 0.9 and Total harmonic index THD < 15%, According to customer requirements can produce a lower THD < 10%.

This type of certification is issued by a government-approved laboratory for Safety certification, Fire testing, Restriction of Hazardous Substances (RoHS), Photobiological safety of lamps and lamp systems. (an Exemption Group) and other test certifications to ensure product quality

光效 (lm/W)、功率 (W)、顯色指數 (CRI)，可根據客戶需求定制。

此型號標準之功率因素 (PF) > 0.9，總諧波指數 THD < 15%，可按客戶需要生產低總諧波指數 < 10%。

此型號認證由可實驗室發出之安全認證消防測試，環保物料 (RoHS)，光生物安全為 Exemption Group 及其它測試，保證客戶使用更安心滿意。



東 權 LED 照 明 公 司  
EASTLIKE LED Co., Ltd

---

**Office Address:** Room B3, 18/F Bonsun Industrial Building,  
364-366 Sha Tsui Road, Tsuen Wan, HongKong

**Phone:** 852-3107 7500

**Fax:** 852-3544 0462

**Whatsapp:** 852-5977 2627

**Email:** [info@eastlike.com](mailto:info@eastlike.com)